

 **synter**

SOLUÇÕES INTELIGENTES



Somos a Synter, uma indústria catarinense localizada na cidade de Forquilha, no sul do estado, que iniciou suas atividades em 1991 produzindo dobradiças e ferragens em aço inoxidável.

O foco na transformação de uma matéria-prima tão nobre moldou o DNA da marca, que passou a ser reconhecida pela durabilidade e resistência de seus produtos.

A evolução de nossos processos nos trouxe a expertise necessária para ampliar constantemente nosso portfólio. Com muito orgulho, em 2005, nos tornamos a única indústria catarinense a produzir fechaduras residenciais. Aqui, o comprometimento com a sua segurança passou a fazer parte dos nossos valores.

Em 2017, iniciamos um intenso período de pesquisa e desenvolvimento com a missão de levar a tecnologia até a porta de casa, o que foi materializado na entrega ao mercado de uma completa linha de fechaduras inteligentes.

Esta nova linha e o gosto pela tecnologia nos trouxeram um mundo de oportunidades. E assim surgiu nosso primeiro aplicativo, o Synter Smart, a chave digital de lares e negócios de muitos de nossos clientes.

São 33 anos de vitórias, transformações e inovações! E o símbolo de todo este crescimento e conquista tem um nome: Synter Access, a plataforma digital da Synter. O conjunto completo de soluções em gerenciamento e compartilhamento de acessos que completa o legado de nossa marca: durabilidade, resistência, segurança e conectividade.

Entre e compartilhe!

## Índice

<b>Soluções Inteligentes</b> .....	05
Synter Access .....	05
Synter Smart .....	06
Produtos Inteligentes .....	07
Fechaduras Inteligentes .....	07
Controladoras de Acesso .....	11
<b>Fechaduras Mecânicas</b> .....	13
Moderna Glow .....	13
Inox Prime.....	15
Acessibilidade Inox .....	17
Unic Inox .....	18
Pop .....	20
Gol .....	21
Auxiliares .....	22
Componentes .....	23
<b>Puxadores</b> .....	25
<b>Dobradiças</b> .....	27
Inox 304 Premium .....	27
Máxima Inox .....	28
Aço Basic .....	28
<b>Ferragens e Acessórios</b> .....	31
<b>Complementares</b> .....	36
Solenóides .....	37
Catracas .....	39
Barra Antipânico .....	41
Acessórios Opcionais .....	44

Fornecer soluções duráveis e seguras que **simplificam e conectam a vida das pessoas** é o nosso propósito.

# synter access

## A forma mais simples de gerenciar e compartilhar acessos.

O Synter Access é uma plataforma intuitiva desenvolvida pela Synter para gerenciar e controlar acessos em ambientes comerciais e residenciais. Com essa solução, é possível integrar diversos pontos, como portas, elevadores e garagens, em uma única tela acessível por computador, notebook ou tablet. A plataforma elimina a necessidade de chaves físicas, permitindo o compartilhamento de acessos de forma fácil e segura, mesmo à distância, através do aplicativo Synter Smart.



**SALÃO DE FESTAS /  
ÁREAS COMUNS**  
FECHADURA INTELIGENTE



**APARTAMENTOS**  
FECHADURA INTELIGENTE



**HALL DE ENTRADA**  
CONTROLADORA COM  
RECONHECIMENTO  
FACIAL



**RECEÇÃO**  
PLATAFORMA  
SYNTER ACCESS



**GARAGEM/PORTÃO**  
CONTROLADORAS  
DE ACESSO



**USUÁRIO**  
APP SYNTER  
SMART

# synter Smart

O app Synter Smart é uma ferramenta intuitiva que permite o gerenciamento completo de um ou mais produtos inteligentes Synter de forma simples e rápida.

Disponível para iOS e android, ele permite ao seu usuário:

- Criar ambientes e controlar a abertura e fechamento dos dispositivos a distância;
  - Enviar chaves digitais temporárias remotamente;
  - Gerenciamento de acessos:
    - Acompanhar as movimentações dos usuários através do aplicativo, com notificações em tempo real;
    - Cadastramento de senhas, administradores, digitais e tag;
- Entre outras funções, dispensando o uso de chaves mecânicas.

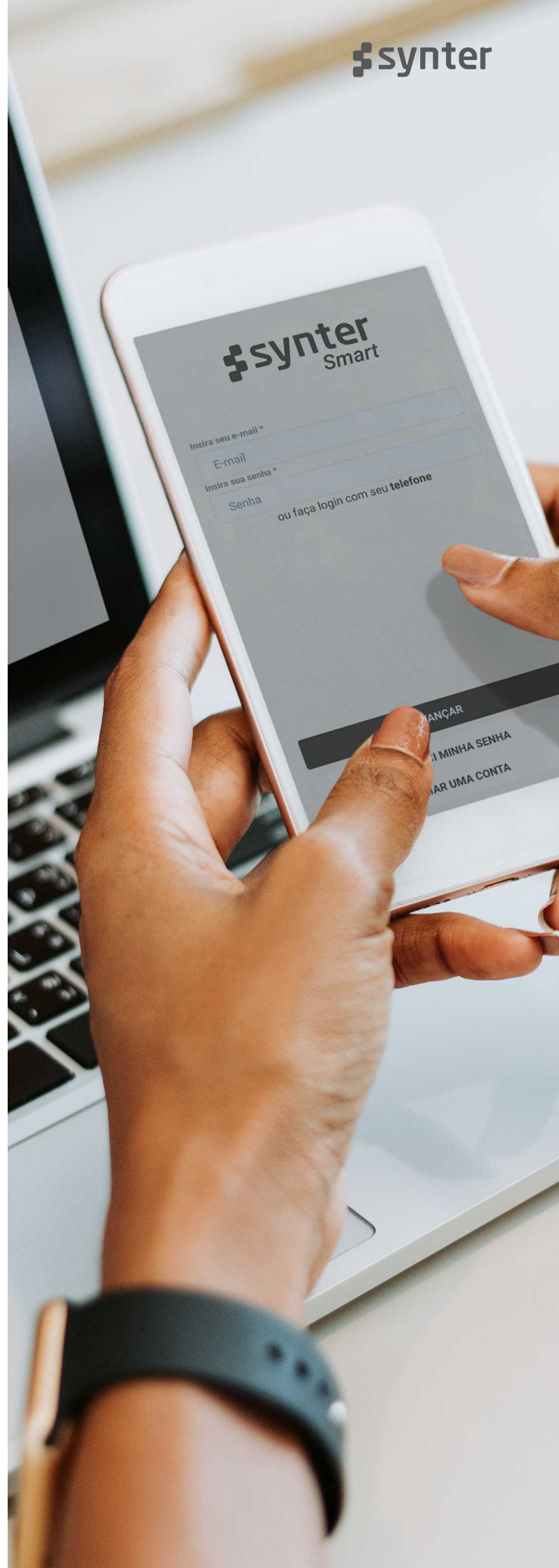

# PRODUTOS INTELIGENTES

Com um design moderno e sofisticado, as fechaduras e controladoras de acesso estão revolucionando a forma como abrimos as portas de nossas casas e negócios. Hoje, você pode acessar seus ambientes de maneira prática, utilizando tecnologias como o reconhecimento facial. Além disso, há opções de abertura em tempo real por meio do Synter Smart, senhas remotas, convites e até biometria. Com diversas maneiras de desbloquear, essas soluções facilitam o seu dia a dia.

## FECHADURAS INTELIGENTES

LANÇAMENTO

# ERIS S2 FACE ID

### Formas de Abertura



Aplicativo  
Synter Smart



Leitor  
Biométrico



Senha  
Numérica



Tag's  
(Compatível com  
Tag's RFID)



Chave de  
Segurança



Abertura com  
Reconhecimento  
Facial

### Conectividade



Wifi



Bluetooth

### Tipo de Instalação



Embutir

### Espessura da Porta



40 ~ 110mm

### Aplicação



Ambiente  
Externo e Interno  
(sem exposição direta ao sol ou maresia)



### Fonte de Alimentação

Bateria  
Recarregável

### Diferenciais



IP65



Modo  
Privacidade



Compatível  
com Alexa  
(com o gateway)



Máquina de  
Alta Segurança





## Syrius S3 Max

### Formas de Abertura



Aplicativo Synter Smart



Leitor Biométrico



Senha Numérica



Tag's (Compatível com Tag's RFID)



Chave de Segurança

### Conectividade



Wifi (com o gateway)



Bluetooth

### Fonte de Alimentação



Alimentação por Pilhas

### Tipo de Instalação



Embutir

### Espessura da Porta



40 ~ 80mm

### Aplicação



Ambiente Externo e Interno (sem exposição direta ao sol ou maresia)



Portas de Madeira de Grande Porte

### Diferenciais



IP55



Modo Privacidade



Máquina de Alta Segurança



Compatível com Alexa (com o gateway)



## Venus S3 PRO

### Formas de Abertura



Aplicativo Synter Smart



Leitor Biométrico



Senha Numérica



Tag's (Compatível com Tag's RFID)



Chave de Segurança

### Conectividade



Wifi (com o gateway)



Bluetooth

### Fonte de Alimentação



Alimentação por Pilhas

### Tipo de Instalação



Embutir

### Espessura da Porta



40 ~ 55mm

### Aplicação



Ambiente Externo e Interno (sem exposição direta ao sol ou maresia)



Portas de giro com uso de Puxador

### Diferenciais



IP65



Modo Privacidade



Compatível com Alexa (com o gateway)



## Syrius S3 PRO

### Formas de Abertura



Aplicativo  
Synter Smart



Leitor  
Biométrico



Senha  
Numérica



Tag's  
(Compatível com  
Tag's RFID)



Chave de  
Segurança

### Conectividade



Wifi  
(com o gateway)



Bluetooth

### Fonte de Alimentação



Alimentação  
por Pilhas



Embutir



35 ~ 55mm

### Aplicação



Ambiente  
Externo e Interno  
(sem exposição direta ao sol ou maresia)

### Diferenciais



IP55



Compatível com  
Alexa  
(com o gateway)

**synter**

## Syrius S2 PRO

### Formas de Abertura



Aplicativo  
Synter Smart



Leitor  
Biométrico



Senha  
Numérica



Tag's  
(Compatível com  
Tag's RFID)



Chave de  
Segurança

### Conectividade



Wifi  
(com o gateway)



Bluetooth

### Fonte de Alimentação



Alimentação  
por Pilhas



Embutir



35 ~ 55mm

### Aplicação



Ambiente Interno  
(sem exposição direta ao sol ou maresia)

### Diferenciais



Compatível com  
Alexa  
(com o gateway)

**synter**

**ERIS S2 FACE ID**

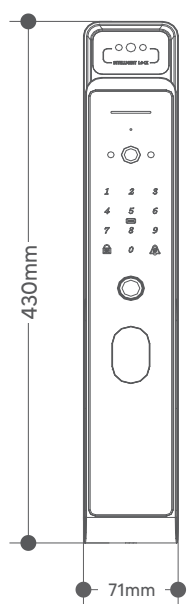

**Syrius S3 MAX**

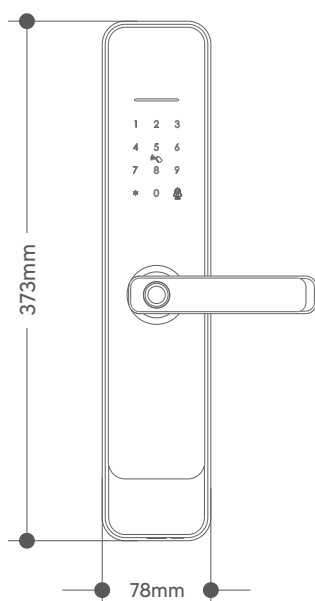

**Venus S3 PRO**

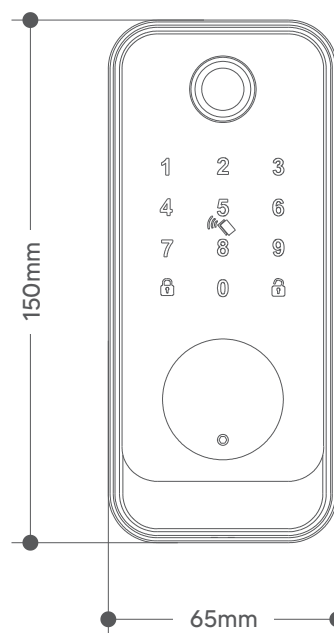

**Syrius S3 PRO**

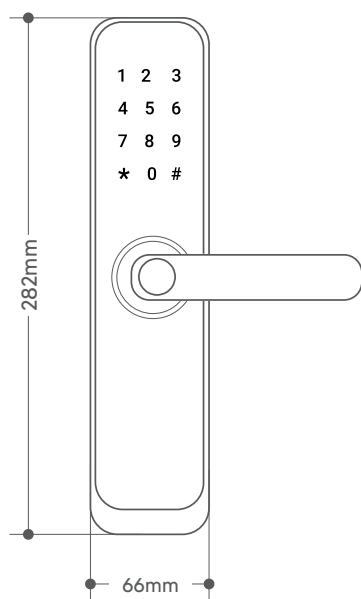

**Syrius S2 PRO**

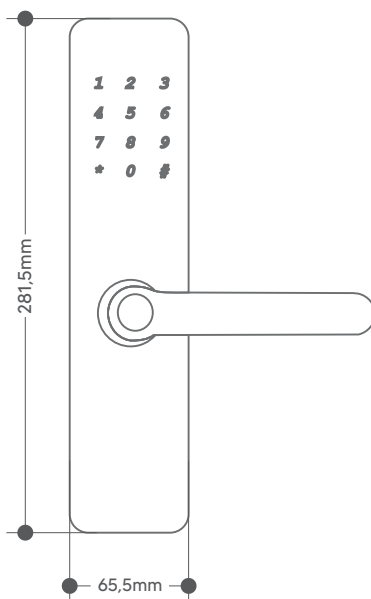

## Controladora de Acesso S2 Pro



### Formas de Abertura



Aplicativo Synter Smart



Leitor Biométrico



Sobrepor



Senha Numérica



Tag's  
(Compatível com Tag's RFID)

### Conectividade



Wifi  
(com o gateway)



Bluetooth

### Fonte de Alimentação



Fonte de Alimentação 12V

### Aplicação



Ambiente Externo e Interno  
(sem exposição direta ao sol ou maresia)



Consultar compatibilidade com sistemas de fechamento

### Diferenciais



IP67

## Controladora de Acesso S2 QR



### Formas de Abertura



Aplicativo Synter Smart



Abertura com QR Code



Sobrepor



Senha Numérica



Tag's  
(Compatível com Tag's RFID)

### Conectividade



Wifi  
(com o gateway)



Bluetooth

### Fonte de Alimentação



Fonte de Alimentação 12V

### Aplicação



Ambiente Externo e Interno  
(sem exposição direta ao sol ou maresia)



Consultar compatibilidade com sistemas de fechamento

### Diferenciais



IP67

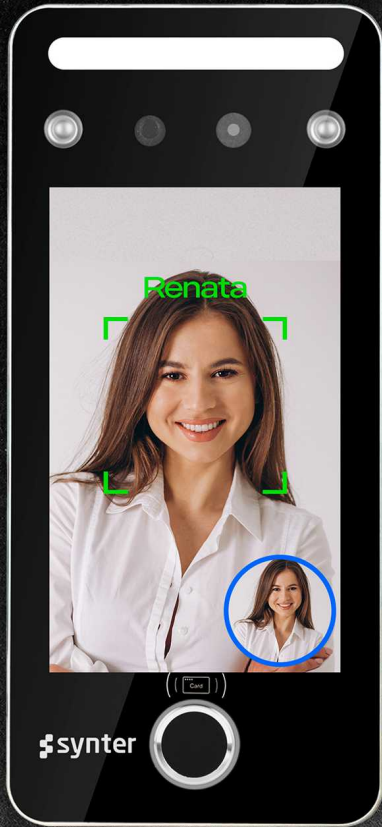

# Controladora de Acesso S2 Face ID

## Formas de Abertura



Aplicativo Synter Smart



Abertura com QR Code



Tag's  
(Compatível com Tag's RFID)



Leitor Biométrico



Senha Numérica



Abertura com Reconhecimento Facial

## Tipo de Instalação



Sobrepor



Ethernet  
(rede cabeada)



## Fonte de Alimentação

Fonte de Alimentação 12V

## Aplicação



Ambiente Interno  
(sem exposição direta ao sol ou marésia)



Consultar compatibilidade com sistemas de fechamento

## Diferenciais



Reconhecimento facial em tempo real



Velocidade de reconhecimento de < 0.2 segundos



Reconhecimento com máscara



Distância de reconhecimento configurável (0.5 a 2.5 metros)



Alarme de arrombamento

## DIMENSÕES DOS PRODUTOS CONTROLADORAS DE ACESSO

**Controladora de Acesso S2 PRO e QR**

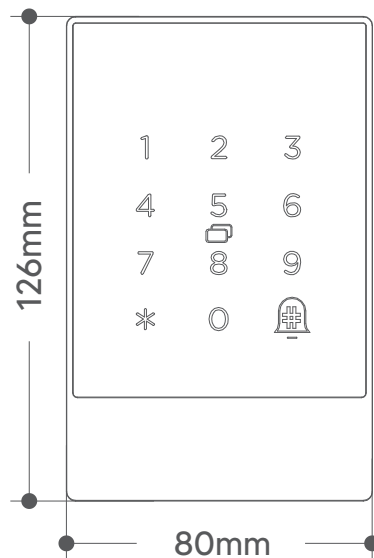

**Controladora de Acesso S2 FACE ID**

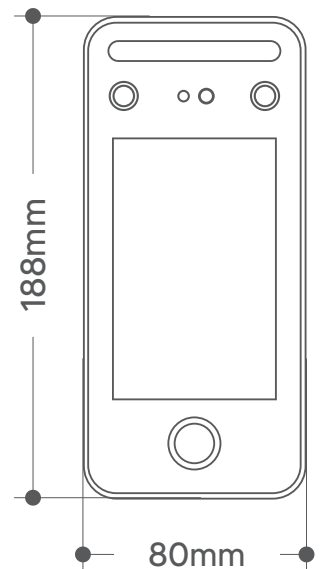

# FECHADURAS MECÂNICAS

As fechaduras são elementos de decoração em todos os ambientes, além de serem um dos principais dispositivos de segurança presentes em todos os projetos. A preocupação com a ergonomia, robustez, durabilidade e custo-benefício são os fatores determinantes para escolher o modelo certo. Combine com máquinas e cilindros adequados à sua necessidade e forme o conjunto ideal.

LANÇAMENTO

## MODERNA GLOW

A arquitetura moderna é a maior inspiração da linha Synter. Design puro em maçanetas de alto padrão voltadas a um público que busca sofisticação e exclusividade. Cores nada convencionais que seguem a máxima do estilo "feitas para brilhar". Perfeitas para combinar em ambientes refinados e com elementos de muita tecnologia.

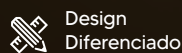

Design  
Diferenciado



Vários  
Acabamentos



Alto  
Padrão

LANÇAMENTO

**Aura** Zamac/Alumínio  
 Roseta: 14 - Máquina: 55mm  
 Função: Ext/Ban  
 Acabamento: Cromado



LANÇAMENTO

**Dorado** Zamac/Alumínio  
 Roseta: 12 - Máquina: 55mm  
 Função: Ext/Ban  
 Acabamento: Gold



LANÇAMENTO

**Fenix** Zamac/Alumínio  
 Roseta: 12 - Máquina: 55mm  
 Função: Ext/Ban  
 Acabamento: Cinza



LANÇAMENTO

**Lyra** Zamac/Alumínio  
 Roseta: 12 - Máquina: 55mm  
 Função: Ext/Ban  
 Acabamento: Bronze



LANÇAMENTO

**Nix** Zamac/Alumínio  
 Roseta: 14 - Máquina: 55mm  
 Função: Ext/Ban  
 Acabamento: Preto



LANÇAMENTO

**Orion** Zamac/Alumínio  
 Roseta: 13 - Máquina: 55mm  
 Função: Ext/Ban  
 Acabamento: Preto



**Acabamentos** | Consulte os acabamentos exclusivos para esta linha.

Design Diferenciado

Indicado para ambientes internos e externos

Utilização em esquadrias de madeira em geral

Não resistente à maresia

# INOX PRIME

A linha Inox Prime é a essência do luxo e da sofisticação em fechaduras de alto padrão. Com design diferenciado e fabricadas com o aço inoxidável mais nobre, nossos produtos são verdadeiras jóias duráveis, que agregam valor e elegância ao ambiente.

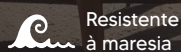
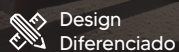
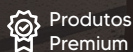
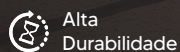

## Acqua Inox

Roseta: 08 - Máquina: 55mm

Função: Ext/Int/Ban

Acabamento: Polido / Escovado



LANÇAMENTO

## Crispus Max Inox

Roseta: 10 - Máquina: 55mm

Função: Ext/Int/Ban

Acabamento: Polido / Escovado



LANÇAMENTO

## Star Max Inox

Roseta: 11 - Máquina: 55mm

Função: Ext/Int/Ban

Acabamento: Polido / Escovado



LANÇAMENTO

## Polo Max Inox

Roseta: 11 - Máquina: 55mm

Função: Ext/Int/Ban

Acabamento: Polido / Escovado



### Luck Inox

Roseta: 09 - Máquina: 55mm  
 Função: Ext/Int/Ban  
 Acabamento: Polido / Escovado / Preto



### Luck Inox

Roseta: 01 - Máquina: 55mm  
 Função: Ext/Int/Ban  
 Acabamento: Polido / Escovado / Preto



### Navis Inox

Roseta: 01 - Máquina: 55mm  
 Função: Ext/Int/Ban  
 Acabamento: Polido / Escovado / Preto



### Navis Inox

Roseta: 04 - Máquina: 55mm / 40mm  
 Função: Ext/Int/Ban  
 Acabamento: Polido / Escovado / Preto



### Navis Inox

Roseta: 09 - Máquina: 55mm  
 Função: Ext/Int/Ban  
 Acabamento: Polido / Escovado / Preto

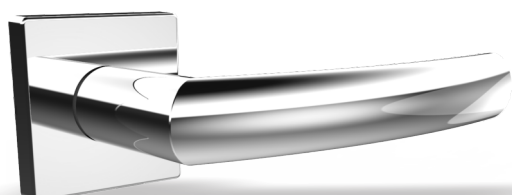

### Navis Inox

Roseta: 07 - Máquina: 55mm / 40mm  
 Função: Ext/Int/Ban  
 Acabamento: Polido / Escovado / Preto

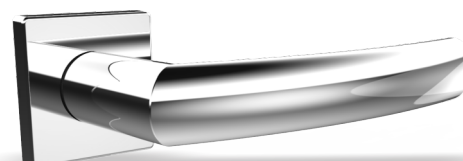

### Star Inox

Roseta: 09 - Máquina: 55mm  
 Função: Ext/Int/Ban  
 Acabamento: Polido / Escovado / Preto



### Star Inox

Roseta: 07 - Máquina: 55mm / 40mm  
 Função: Ext/Int/Ban  
 Acabamento: Polido / Escovado / Preto

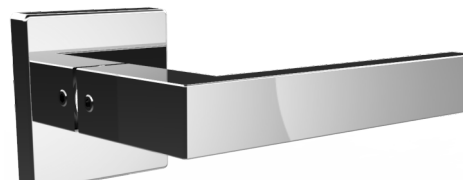

- Alta Durabilidade
- Produtos Premium
- Indicado para ambientes internos e externos
- Design Diferenciado
- Resistente à maresia
- Utilização em esquadrias de madeira em geral

**Acabamentos com excelência** | Maçanetas, rosetas, falsa testa e contra testa em aço inoxidável;  
 Disponibilidade de cilindros 70mm multiponto ou 56mm convencional



### DIMENSÕES DOS PRODUTOS - LINHA INOX PRIME

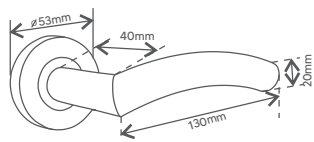

Acqua 08 - Redonda Grande

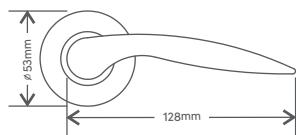

Crispus Max 10 - Redonda Grande

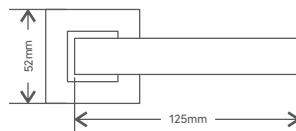

Star Max 10 - Quadrada Grande

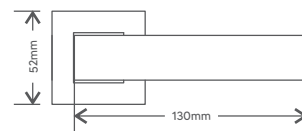

Polo Max 11 - Quadrada Grande

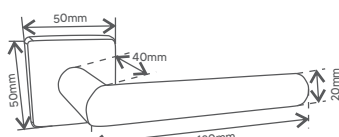

Luck 09 - Quadrada Grande

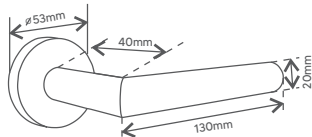

Luck 01 - Redonda Grande

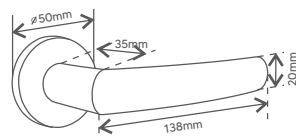

Navis 01 - Redonda Grande

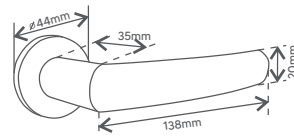

Navis 04 - Redonda Pequena

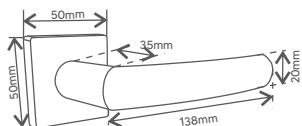

Navis 09 - Quadrada Grande

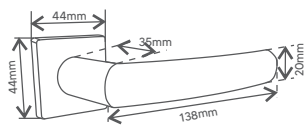

Navis 07 - Quadrada Pequena

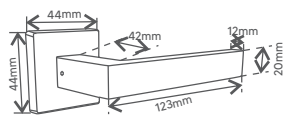

Star 07 - Quadrada Pequena

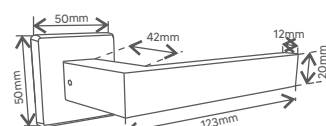

Star 09 - Quadrada Grande

# ACESSIBILIDADE INOX

## Ceci Inox

Roseta: 01 - Máquina: 55mm  
Função: Ext/Int/Ban  
Acabamento: Escovado / Preto

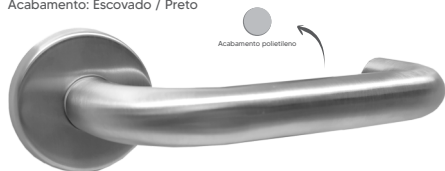

## Ceci Inox

Roseta: 10 - Máquina: 55mm  
Função: Ext/Int/Ban  
Acabamento: Escovado / Preto

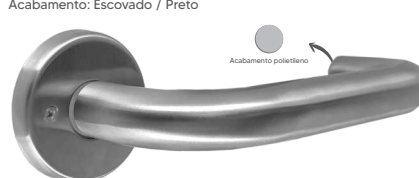

## Barra de apoio Inox

Tamanho: 400mm  
Tamanho: 600mm  
Acabamento: Polido / Preto



### Acabamentos com excelência

Maçanetas, rosetas, falsa testa e contra testa em aço inoxidável;  
Disponibilidade de cilindros 70mm multiponto ou 56mm convencional;



Produtos Premium



Indicado para ambientes hospitalares



Alta Durabilidade



Resistente à maresia

### DIMENSÕES DOS PRODUTOS - LINHA ACESSIBILIDADE INOX

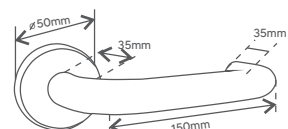

Ceci 01 - Redonda Grande

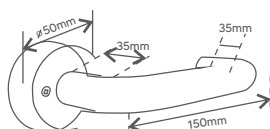

Ceci 10 - Redonda Grande c/ parafuso aparente

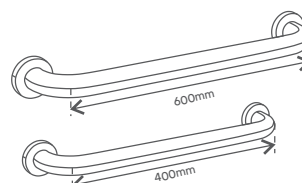

Barra 600mm ou 400mm

# UNIC INOX

A linha Unic Inox nasce da exploração das formas primárias, trazendo consigo um design acessível e minimalista, com linhas curvas e retas. Em outras palavras, as peças dessa linha têm a clara ambição de se harmonizarem com qualquer ambiente - e elas cumprem esse propósito com maestria, cuidando de cada mínimo detalhe.

 Alta Durabilidade

 Resistente à maresia



## Champion Inox

Roseta: 09 - Máquina: 55mm  
Função: Ext/Int/Ban  
Acabamento: Polido / Escovado / Preto

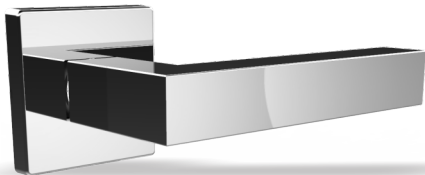

## Champion Inox

Roseta: 07 - Máquina: 55mm / 40mm  
Função: Ext/Int/Ban  
Acabamento: Polido / Escovado / Preto

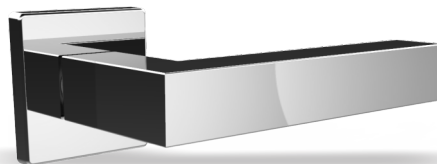

## Marine Inox

Roseta: 09 - Máquina: 55mm  
Função: Ext/Int/Ban  
Acabamento: Polido / Preto



## Marine Inox

Roseta: 07 - Máquina: 55mm / 40mm  
Função: Ext/Int/Ban  
Acabamento: Polido / Preto



## Marine Inox

Roseta: 01 - Máquina: 55mm  
Função: Ext/Int/Ban  
Acabamento: Polido / Preto



## Marine Inox

Roseta: 04 - Máquina: 55mm / 40mm  
Função: Ext/Int/Ban  
Acabamento: Polido / Preto



### Marine Color Inox

Roseta: 09 - Máquina: 55mm  
 Função: Ext/Int/Ban  
 Acabamento: Escovado / Preto

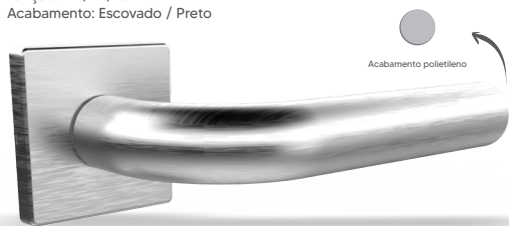

### Marine Color Inox

Roseta: 07 - Máquina: 55mm / 40mm  
 Função: Ext/Int/Ban  
 Acabamento: Escovado / Preto

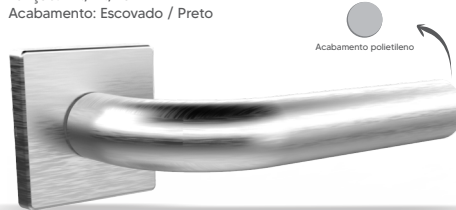

### Marine Color Inox

Roseta: 01 - Máquina: 55mm  
 Função: Ext/Int/Ban  
 Acabamento: Escovado / Preto



### Marine Color Inox

Roseta: 04 - Máquina: 55mm / 40mm  
 Função: Ext/Int/Ban  
 Acabamento: Escovado / Preto

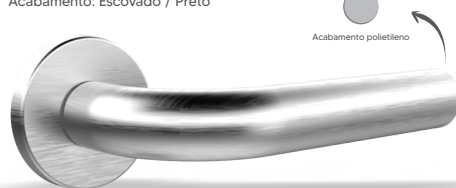

### Navis II Inox

Roseta: 01 - Máquina: 55mm  
 Função: Ext/Int/Ban  
 Acabamento: Polido / Escovado / Preto

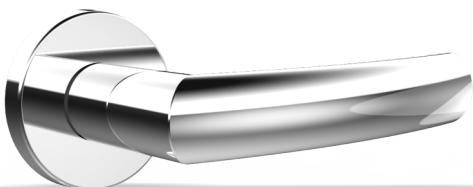

### Navis II Inox

Roseta: 04 - Máquina: 55mm / 40mm  
 Função: Ext/Int/Ban  
 Acabamento: Polido / Escovado / Preto

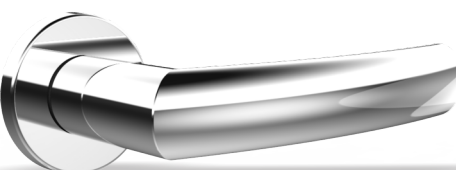

### Navis II Inox

Roseta: 09 - Máquina: 55mm  
 Função: Ext/Int/Ban  
 Acabamento: Polido / Escovado / Preto

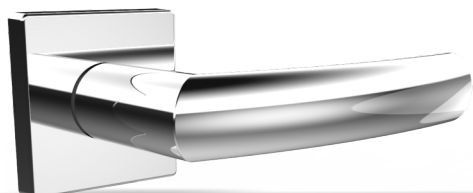

### Navis II Inox

Roseta: 07 - Máquina: 55mm / 40mm  
 Função: Ext/Int/Ban  
 Acabamento: Polido / Escovado / Preto

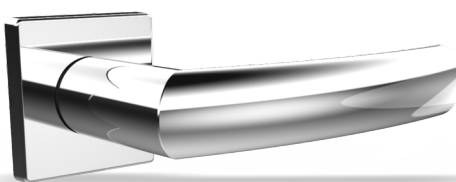

#### Acabamentos com excelência

Maçanetas, rosetas, falsa testa e contra testa em aço inoxidável;  
 Disponibilidade de cilindros 70mm multiponto ou 56mm convencional

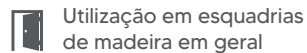
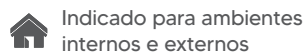

DIMENSÕES DOS PRODUTOS - LINHA UNIC INOX

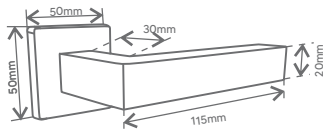

Champion 09 - Quadrada Grande

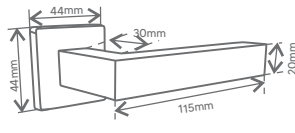

Champion 07 - Quadrada pequena

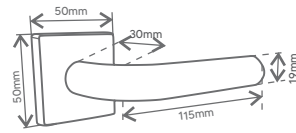

Marine 09 - Quadrada Grande

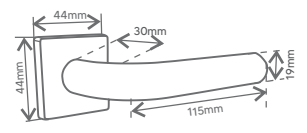

Marine 07 - Quadrada pequena

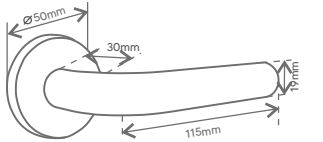

Marine 01 - Redonda Grande

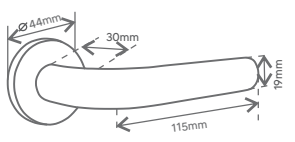

Marine 04 - Redonda pequena

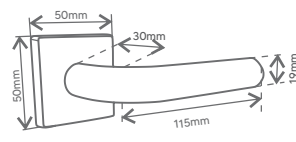

Marine Color 09 - Quadrada Grande

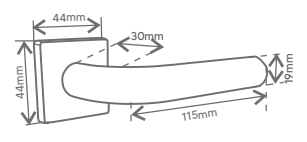

Marine Color 07 - Quadrada pequena

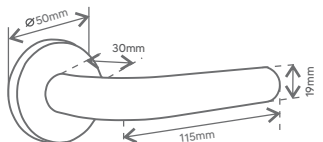

Marine Color 01 - Redonda Grande

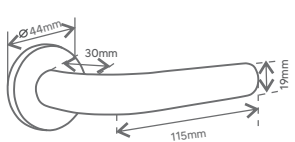

Marine Color 04 - Redonda pequena

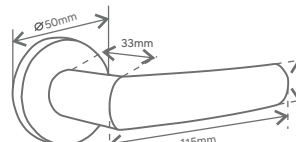

Navis II 01 - Redonda Grande

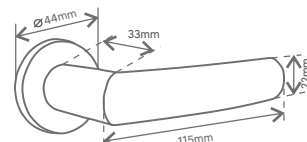

Navis II 04 - Redonda pequena

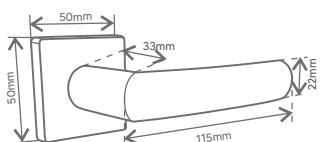

Navis II 09 - Quadrada Grande

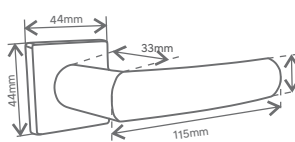

Navis II 07 - Quadrada pequena

# POP

Uma solução acessível e funcional para a segurança de residências e estabelecimentos comerciais. De design contemporâneo, ela combina estilo e praticidade.

## Stillus

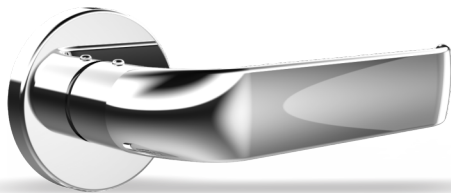

Roseta: 04 - Máquina: 55mm / 40mm  
Função: Ext/Int/Ban  
Acabamento: Cromado / Preto **Zamak**

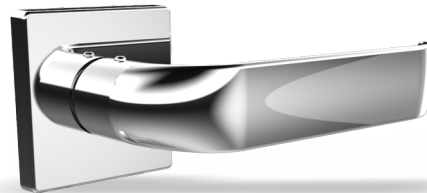

Roseta: 07 - Máquina: 55mm / 40mm  
Função: Ext/Int/Ban  
Acabamento: Cromado / Preto **Zamak**



Roseta: 05 - Máquina: 55mm / 40mm  
Função: Ext/Int/Ban  
Acabamento: Cromado / Preto **Zamak**

**Acabamentos com excelência** | Espelhos, rosetas, falsa testas e contra testa em aço inoxidável; Disponibilidade de cilindro 56mm convencional

Indicado para ambientes internos e externos com restrição

Utilização em esquadrias de madeira em geral

Não resistente à maresia

DIMENSÕES DOS PRODUTOS - LINHA POP

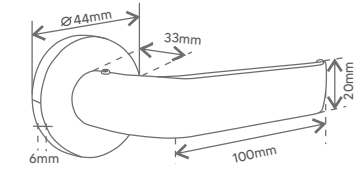

Stillus 04 - Redonda Pequena

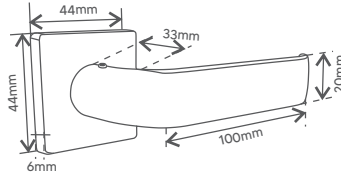

Stillus 07 - Quadrada Pequena

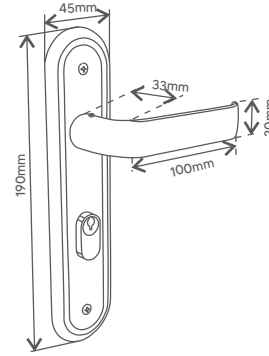

Stillus 05 - Espelho

# GOL

Combinando funcionalidade e preço acessível, ela conquista aqueles que buscam segurança sem comprometer a qualidade.

## Gol

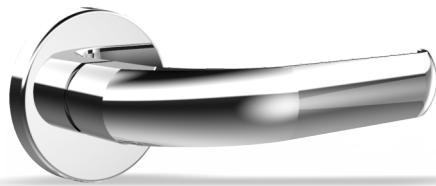

Roseta: 04 - Máquina: 40mm  
Função: Ext/Int/Ban  
Acabamento: Cromado **Zamak**

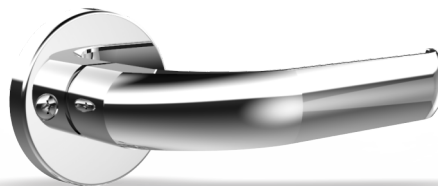

Roseta: 06 - Máquina: 40mm  
Função: Ext/Int/Ban  
Acabamento: Cromado **Zamak**



Roseta: 05 - Máquina: 40mm  
Função: Ext/Int/Ban  
Acabamento: Cromado **Zamak**

**Acabamentos com excelência** | Espelhos, rosetas, falsa testa e contra testa em aço inoxidável;  
Disponibilidade de cilindro 56mm convencional;

Indicado para ambientes internos e externos com restrição

Utilização em esquadrias de madeira em geral

Não resistente à maresia

DIMENSÕES DOS PRODUTOS - LINHA GOL

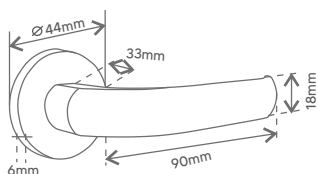

Gol 04 - Redonda Pequena

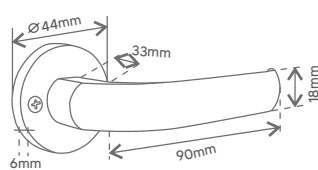

Gol 06 - Redonda Pequena c/ parafuso aparente

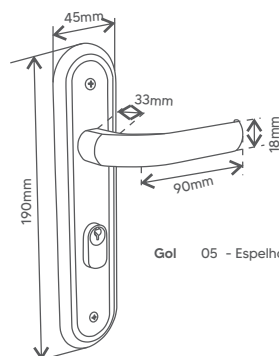

Gol 05 - Espelho

# AUXILIARES

Nossas linhas de fechaduras Auxiliares são cuidadosamente projetadas para manter um elevado grau de qualidade visual, presente em todas as nossas linhas de produtos. Dessa forma, você tem à disposição uma linguagem coerente que se adapta perfeitamente a qualquer ambiente, transmitindo uma aparência harmoniosa em cada cenário.

## Fechadura para Porta de Correr



## Fechadura Rolete



\*Disponível também com testa quadrada

### Acabamentos com excelência

Maçanetas, rosetas, falsa testa e contra testa em aço inoxidável;  
Disponibilidade de cilindros 70mm multiponto ou 56mm convencional

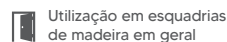
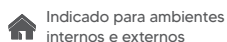

## DIMENSÕES DOS PRODUTOS - AUXILIARES

Fechadura para Porta de Correr

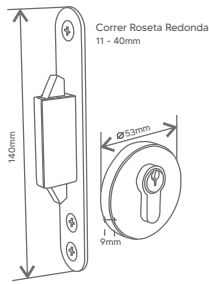
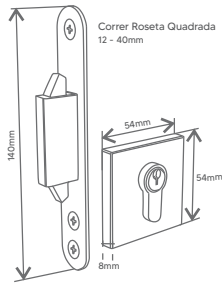

Fechadura Rolete

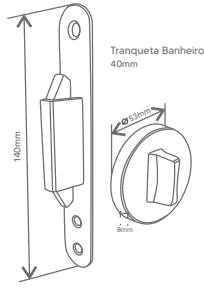
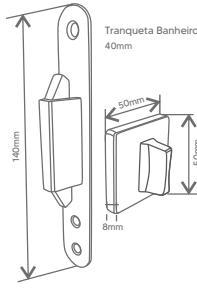
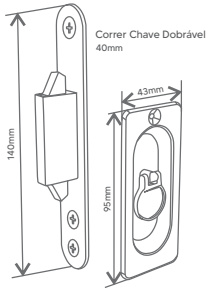
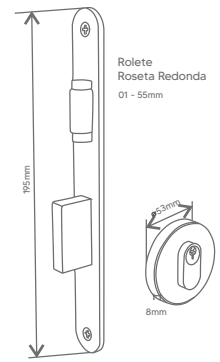
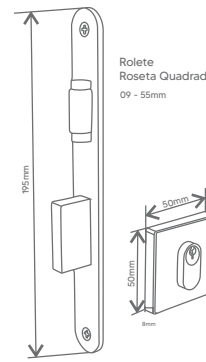

# COMPONENTES

## 1- Tipos de Rosetas

Roseta Grande Redonda - Inox  
Ref.: 01

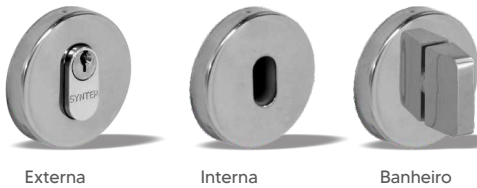

Roseta Grande Quadrada - Inox  
Ref.: 09

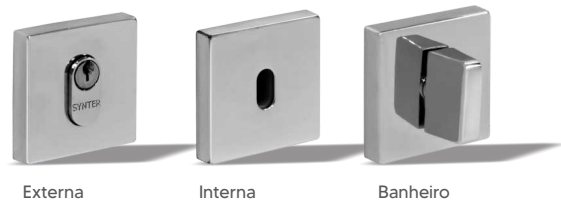

Roseta Pequena Redonda - Inox  
Ref.: 04



Roseta Pequena Quadrada - Inox  
Ref.: 07

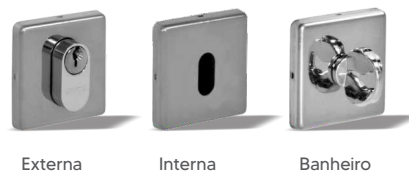

## Sistema de retorno de Mola (CRM)

Item aplicado em rosetas grandes



CRM é uma peça que aplicada entre a haste e a roseta reforça o retorno da maçaneta a sua posição original. Em resumo, ele evita que a maçaneta fique com o aspecto de caída.

## 2- Máquinas

Tamanho de Broca 55mm  
Canto Redonda e Quadrada

Tamanho de Broca 40mm  
Canto Redonda e Quadrada

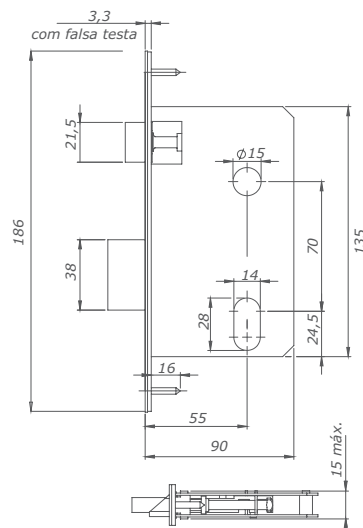

Máquina: 55mm

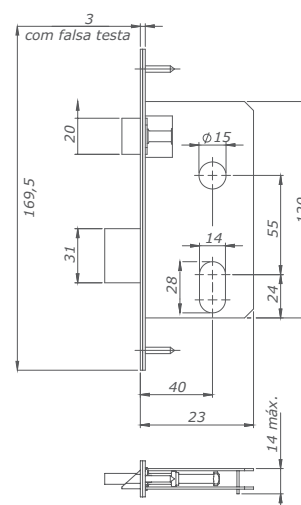

Máquina: 40mm

Frequência de Uso	Tamanho de Maq.	Utilização da Fechadura
Tráfego Intenso	Máquina 55mm	Residências, consultórios, escritórios, hospitais, shoppings centers, etc
Tráfego Médio	Máquina 55 e 40mm	Residências, consultórios, escritórios, etc.
Tráfego Leve	Máquina 40mm	Residências, comunicação entre cômodos, etc.
Grau de resistência à corrosão	Acabamentos	Utilização da Fechadura
4	Inox Polido e Escovado	Com condições severas quanto à umidade e intempéries (ex: região litorânea e industriais)
3	Inox Polido e Escovado	Com umidade e intempéries (ex: áreas externas urbanas e rurais)
2	Cromado	Com umidade e sem intempéries (ex: cozinhas e banheiros)
1	Cromado	Sem umidade e sem intempéries (ex: salas e dormitórios)
Grau de segurança	Utilização da Fechadura	
Máxima	Porta externa, interna e banheiro	
Muito Alta	Porta externa, interna e banheiro	
Alta	Porta externa, interna e banheiro	
Média	Porta externa, interna e banheiro	
Média	Porta interna e banheiro	

## 3- Cilindros

Cilindro Multiponto / 70mm latão  
Ref.: CILEZ1CR

Cilindro padrão Yale / 56mm zamac  
Ref.: CILE5CR





# PUXADORES

## Jade Max

Tamanho: 1200mm / 800mm  
Acabamento: Polido / Escovado / Preto

inox



## Jade

Tamanho: 1200mm / 800mm / 600mm  
Acabamento: Polido / Escovado / Preto

inox



## Opala

Tamanho: 1200mm / 800mm / 600mm  
Acabamento: Polido / Escovado / Preto

inox



## Quartzo

Tamanho: 800mm / 300mm  
Acabamento: Polido / Escovado / Preto

inox

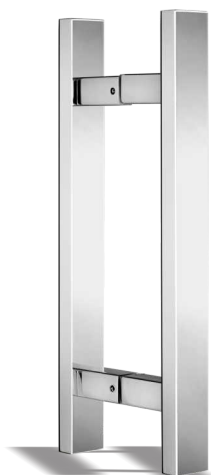

## Jaspe com Furo

Tamanho: 520mm / 320mm / 220mm  
Acabamento: Polido / Escovado / Preto

inox



## Jaspe

Tamanho: 520mm / 320mm / 220mm  
Acabamento: Polido / Escovado / Preto

inox



 Alta Durabilidade

 Ecologicamente Correto

 Resistente à maresia

 Utilização em esquadrias de madeira em geral

 Indicado para ambientes internos e externos

### Jade Max

1200mm / 800mm

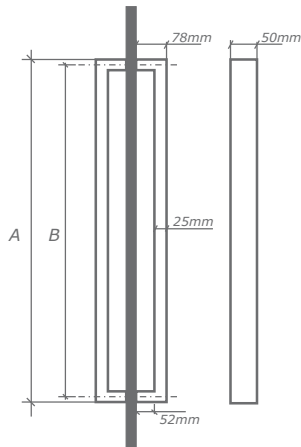

Referência	A	B
PUXJADE1200	1200mm	1175mm
PUXJADE800	800mm	775mm

### Jade

1200mm / 800mm / 600mm

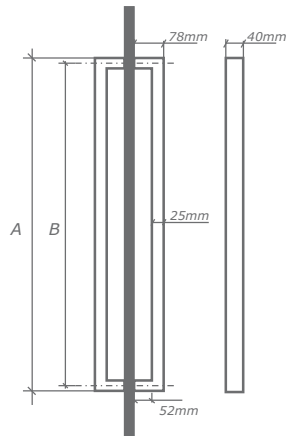

Referência	A	B
PUXJADE1200	1200mm	1175mm
PUXJADE800	800mm	775mm
PUXJADE600	600mm	575mm

### Opala

1200mm / 800mm / 600mm

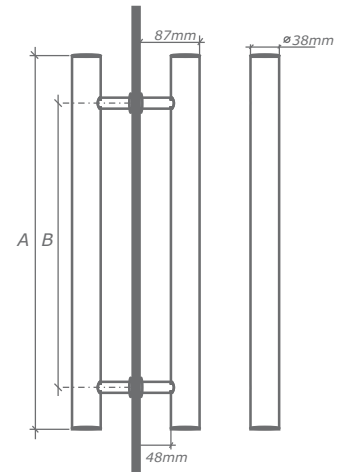

Referência	A	B
PUXOPALA1200	1200mm	800mm
PUXOPALA800	800mm	600mm
PUXOPALA600	600mm	400mm

### Quartzo

800mm / 300mm

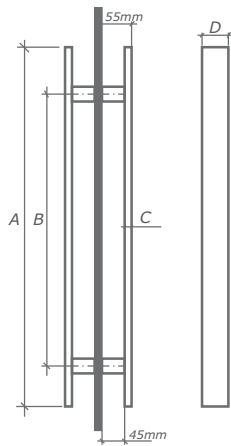

Referência	A	B	C	D
PUXQUARTZO800	800mm	600mm	10mm	40mm
PUXQUARTZO300	300mm	200mm	15mm	30mm

### Jaspe com Furo

520mm / 320mm / 220mm

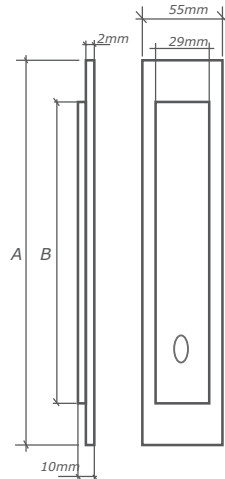

Referência	A	B
PUXJASPCFIP520S	520mm	484mm
PUXJASPCFIP320S	320mm	284mm
PUXJASPCFIP200S	220mm	184mm

### Jaspe

520mm / 320mm / 220mm

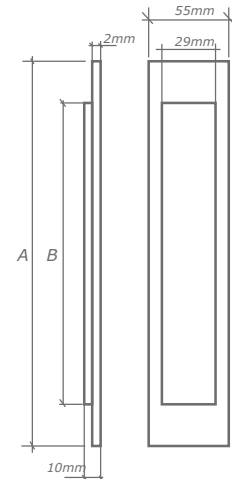

Referência	A	B
PUXJASPEIP520S	520mm	484mm
PUXJASPEIP320S	320mm	284mm
PUXJASPEIP220S	220mm	184mm

# DOBRADIÇAS INOX 304 PREMIUM

## Dobradiça Com Rolamento

Canto Reto

inox



Referência	Dimensões	Acabamento
706IXP	3x2 1/2 "	Inox Polido
701IXP	3 1/2 x 3"	Inox Polido
700IXP	3 1/2 x 3"	Inox Escovado
705IXP	3x2 1/2 "	Inox Escovado

## Dobradiça Com Rolamento

Raio 16

inox



Referência	Dimensões	Acabamento
700IER16P	3 1/2 x 3"	Inox Escovado
701IPR16P	3 1/2 x 3"	Inox Polido
705IER16P	3x2 1/2 "	Inox Escovado
706IPR16P	3x2 1/2 "	Inox Polido

## Dobradiça Pino Pivotante

inox

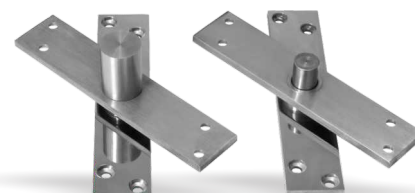

Referência	Dimensões	Acabamento
800PIP	Até 80kg	Inox Polido
810PIP	Até 250kg	Inox Polido

## Dobradiça Americana

Canto Reto

inox



Referência	Dimensões	Acabamento
30I	3"	Inox Polido
40I	3 1/2 "	Inox Polido
54I	3x2 1/2 "	Inox Polido
56I	3x3"	Inox Polido

## Dobradiça Americana

Raio 16

inox



Referência	Dimensões	Acabamento
54IPR16	3x2 1/2 "	Inox Polido
54IER16	3x2 1/2 "	Inox Escovado



Resistente à maresia



Alta Durabilidade



Aço Inoxidável



Qualidade garantida

# DOBRADIÇAS MÁXIMA INOX

Dobradiça  
**Com Rolamento**

Canto Reto

inox



Referência	Dimensões	Acabamento
105IXP	3x2 1/2"	Inox Escovado
106IXP	3x2 1/2"	Inox Polido
100IXP	3 1/2 x 3"	Inox Escovado
101IXP	3 1/2 x 3"	Inox Polido

Dobradiça  
**Com Rolamento**

Raio 16

inox



Referência	Dimensões	Acabamento
105IER16P	3x2 1/2"	Inox Escovado
106IPR16P	3x2 1/2"	Inox Polido
100IER16P	3 1/2 x 3"	Inox Escovado
101IPR16P	3 1/2 x 3"	Inox Polido

Dobradiça  
**Sobrepôr**

Canto Reto

inox



Referência	Dimensões	Acabamento
360SIEP	4x3"	Inox Escovado

Aço Inoxidável
 Durabilidade
 Qualidade garantida

# DOBRADIÇAS AÇO BASIC

Dobradiça  
**Com Anéis**

Canto Reto

Aço Cromado



Referência	Dimensões	Acabamento
105FCP	3x2 1/2"	Cromado

Dobradiça  
**Com Anéis**

Raio 16

Aço Cromado



Referência	Dimensões	Acabamento
105FCR16P	3x2 1/2"	Cromado

Dobradiça  
**Sobrepôr**

Canto Reto

Aço Cromado



Referência	Dimensões	Acabamento
360SFCP	4x3"	Cromado

Dobradiça  
**Pino Luxo**

Canto Reto

Aço Cromado



Referência	Dimensões	Acabamento
601FCP	3x2 1/2"	Cromado

Produto acessível
 Qualidade garantida

Dobradiça  
**Pino Luxo**

Raio 16

Aço Cromado



Referência	Dimensões	Acabamento
601FCR16P	3x2 1/2"	Cromado

Dobradiça  
**Pino Simples**

Canto Reto

Aço Zincado



Referência	Dimensões	Acabamento
30FZP	3"	Zincado
40FZP	3 1/2"	Zincado
50FZP	3x2 1/2"	Zincado

Dobradiça  
**Pino Simples**

Raio 16

Aço Zincado



Referência	Dimensões	Acabamento
50FZR16P	3x2 1/2"	Zincado

Dobradiça  
**Pino Simples**

Raio 16

Aço Zincado



Referência	Dimensões	Acabamento
550FZR16P	3x2 1/2"	Zincado

**DIMENSÕES DOS PRODUTOS - DOBRADIÇAS INOX 304 PREMIUM**

Dobradiça  
**Com Rolamento** inox

Canto Reto

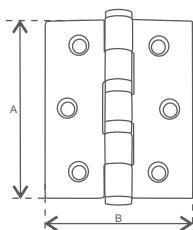

Referência	Dimensões	Medidas A	Medidas B	Espessura
706IXP	3x2 1/2"	76mm	64mm	2mm
701IXP	3 1/2 x 3"	89mm	76mm	2mm
700IXP	3 1/2 x 3"	89mm	76mm	2mm
705IXP	3x2 1/2"	76mm	64mm	2mm

Dobradiça  
**Com Rolamento** inox

Raio 16

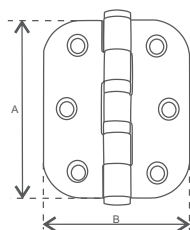

Referência	Dimensões	Medidas A	Medidas C	Espessura
700IER16P	3 1/2 x 3"	89mm	76mm	2mm
701IPR16P	3 1/2 x 3"	89mm	76mm	2mm
705IER16P	3x2 1/2"	76mm	64mm	2mm
706IPR16P	3x2 1/2"	76mm	64mm	2mm

Dobradiça  
**Pino Pivotante** inox

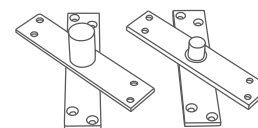

Referência	Dimensões	Medidas A	Medidas B	Medidas C
800PIP	Até 80kg	100mm	25mm	5mm
810PIP	Até 250kg	140mm	30mm	5mm

Dobradiça  
**Americana** inox

Canto Reto

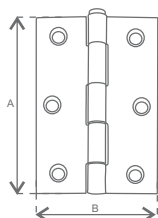

Referência	Dimensões	Medidas A	Medidas B	Espessura
30I	3"	76mm	50mm	2mm
40I	3 1/2"	85mm	76mm	2mm
40I	3 1/2"	85mm	76mm	2mm
54I	3x2 1/2"	76mm	62mm	2mm
56I	3x3"	76mm	75mm	2mm

Dobradiça  
**Americana** inox

Pino Simples / Raio 16

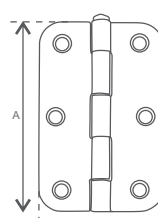

Referência	Dimensões	Medidas A	Medidas B	Espessura
54IPR16	3x2 1/2"	76mm	62mm	2mm
54IER16	3x2 1/2"	76mm	62mm	2mm

## DIMENSÕES DOS PRODUTOS - DOBRADIÇAS MÁXIMA INOX

Dobradiça  
**Com Rolamento** inox  
Canto Reto

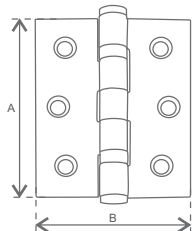

Referência	Dimensões	Medidas A	Medidas B	Espessura
10SIXP	3x2 1/2"	76mm	64mm	2mm
104IXP	3x2 1/2"	76mm	64mm	2mm
100IXP	3 1/2 x 3"	89mm	76mm	2mm
101IXP	3 1/2 x 3"	89mm	76mm	2mm

Dobradiça  
**Com Rolamento** inox  
Raio 16

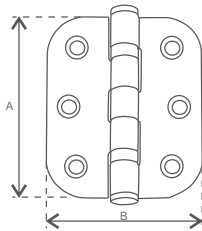

Referência	Dimensões	Medidas A	Medidas B	Espessura
10SIER16P	3x2 1/2"	76mm	64mm	2mm
106IPR16P	3x2 1/2"	76mm	64mm	2mm
100IER16P	3 1/2 x 3"	89mm	76mm	2mm
101IPR16P	3 1/2 x 3"	89mm	76mm	2mm

Dobradiça  
**Sobrepor** inox  
Canto Reto

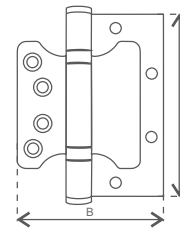

Referência	Dimensões	Medidas A	Medidas B	Espessura
360SIEP	4x3"	100mm	74mm	3mm

## DIMENSÕES DOS PRODUTOS - DOBRADIÇAS AÇO CROMADO BASIC

Dobradiça  
**Com Anéis** Aço Cromado  
Canto Reto

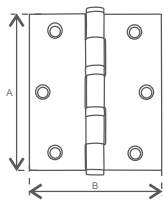

Referência	Dimensões	Medidas A	Medidas B	Espessura
105FCP	3x2 1/2"	76mm	64mm	2mm

Dobradiça  
**Com Anéis** Aço Cromado  
Raio 16

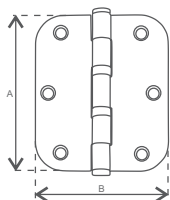

Referência	Dimensões	Medidas A	Medidas B	Espessura
105FCR16P	3x2 1/2"	76mm	64mm	2mm

Dobradiça  
**Sobrepor** Aço Cromado  
Canto Reto

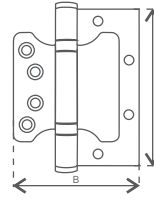

Referência	Dimensões	Medidas A	Medidas B	Espessura
360SFCP	4x3"	100mm	74mm	3mm

Dobradiça  
**Pino Luxo** Aço Cromado  
Canto Reto

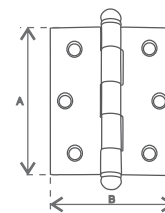

Referência	Dimensões	Medidas A	Medidas B	Espessura
60IFCP	3x2 1/2"	76mm	64mm	2mm

Dobradiça  
**Pino Luxo** Aço Cromado  
Raio 16

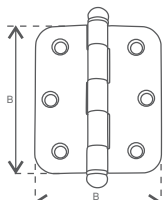

Referência	Dimensões	Medidas A	Medidas B	Espessura
60IFCR16P	3x2 1/2"	76mm	64mm	2mm

Dobradiça  
**Pino Simples** Aço Zincado

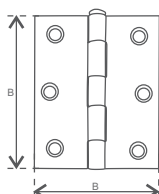

Referência	Dimensões	Medidas A	Medidas B	Espessura
30FZ	3"	76mm	50mm	2mm
40FZ	3 1/2"	85mm	76mm	2mm
50FZ	3x2 1/2"	76mm	62mm	2mm

Dobradiça  
**Pino Simples**  
Raio 16  
Aço Zincado

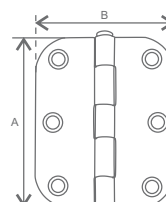

Referência	Dimensões	Medidas A	Medidas B	Espessura
50FZR16	3x2 1/2"	76mm	62mm	1,5mm
550FZR16	3x2 1/2"	76mm	62mm	2mm

# FERRAGENS

## Fecho Fio Redondo

Polido / Preto - sob consulta

inox



## Fecho Pino Bola

Polido / Preto - sob consulta

inox



## Fecho Fio Chato

Polido / Preto - sob consulta

inox

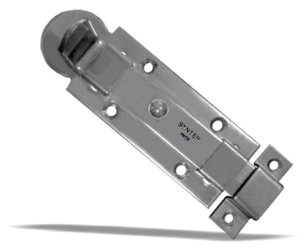

## Fecho Porta Cadeado

Polido / Preto - sob consulta

inox

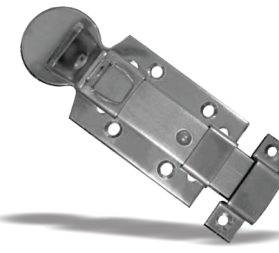

## Fecho Concha Trava

Polido / Preto - sob consulta

inox



## Fecho para janela de correr

Polido / Preto - sob consulta

inox



## Concha Stand com furo

Polido / Preto - sob consulta

inox



## Concha Stand

Polido / Preto - sob consulta

inox



## Alça

Polido / Preto - sob consulta

inox



## Borboleta para Guilhotina

Polido / Preto - sob consulta

inox



## Levantador de Guilhotina

Polido / Preto - sob consulta

inox



## Prendedor para Veneziana

Polido / Preto - sob consulta

inox



**Cremona**

Polido / Preto - sob consulta

inox



**Vara para Cremona**

Polido / Preto - sob consulta

inox



**Gancho de Rede**

Polido / Preto - sob consulta

inox



**Prendedor de Porta Magnético**

Polido / Preto - sob consulta

inox



**Prendedor de Porta Magnético**

Polido / Preto - sob consulta

inox



**Números (1-9 fixação dupla face)**

Polido / Preto - sob consulta

inox



**Números (1-9)**

Polido / Preto - sob consulta

inox



**Porta Cadeado**

Polido / Preto - sob consulta

inox



**Targeta**

Polido / Preto - sob consulta

inox

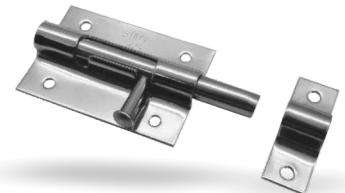

**Dobradiça Basculante (gonzo)**

Polido / Preto - sob consulta

inox

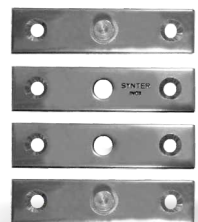

**Dobradiça Basculante (gonzo)**

Polido / Preto - sob consulta

inox

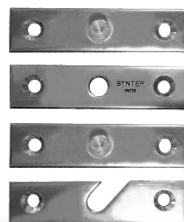

**Dobradiça Leme**

Polido / Preto - sob consulta

inox



 Alta Durabilidade

 Ecologicamente Correto

 Indicado para ambientes internos e externos

 Resistente à maresia

 Utilização em esquadrias de madeira em geral



**Fecho Fio Redondo**

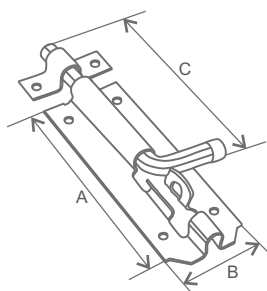

Referência	Dimensões	Acabamento
282I	75x34x70mm	Inox Polido
283I	100x35x100mm	Inox Polido
285I	100x38x150,3mm	Inox Polido
286I	150x38x150,3mm	Inox Polido
288I	150x38x229mm	Inox Polido

\*sequência AxBxC

**Fecho Pino Bola**

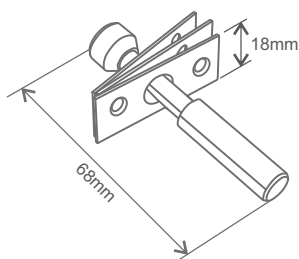

Referência	Dimensões	Acabamento
10I	70x18mm	Inox Polido

**Fecho Fio Chato**

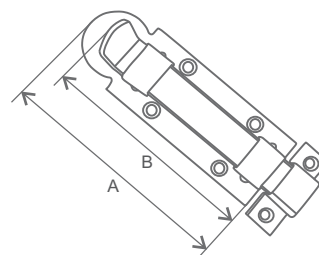

Referência	Dimensões	Acabamento
251I	62,2x20mm	Inox Polido
250I	88x30mm	Inox Polido

\*sequência AxB

**Fecho Porta Cadeado**

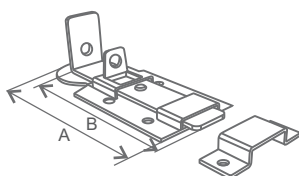

Referência	Dimensões	Acabamento
310I	108x47mm	Inox Polido
311I	129,3x47mm	Inox Polido
312I	154x47mm	Inox Polido

\*sequência AxB

**Fecho Concha Trava**

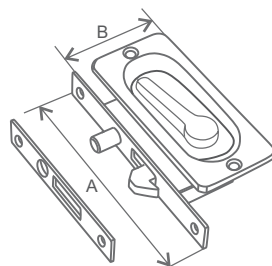

Referência	Dimensões	Acabamento
235I	110x61mm	Inox Polido
235IO	110x61mm	Inox Oxidado

\*sequência AxB

**Fecho para janela de correr**

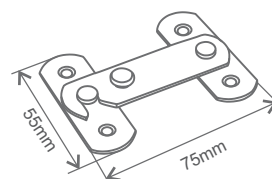

Referência	Dimensões	Acabamento
5I	75x55mm	Inox Polido
5IO	75x55mm	Inox Oxidado

\*sequência AxB

**Concha Stand com furo**

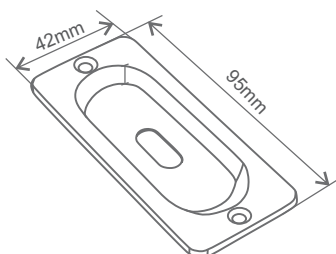

Referência	Dimensões	Acabamento
234I	95x42mm	Inox Polido

**Concha Stand**

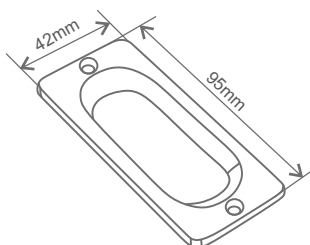

Referência	Dimensões	Acabamento
233I	95x42mm	Inox Polido
233IO	95x42mm	Inox Polido

**Alça**

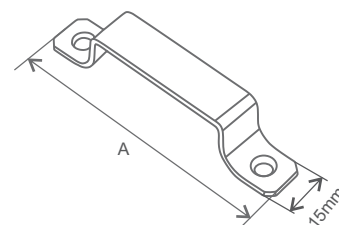

Referência	Dimensões	Acabamento
300I	88x15mm	Inox Polido
301I	111,80x15mm	Inox Polido
302I	137x15mm	Inox Polido

\*sequência AxB

### Borboleta para Guilhotina

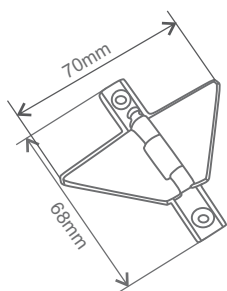

Referência	Dimensões	Acabamento
200I	68x70mm	Inox Polido

### Levantador de Guilhotina

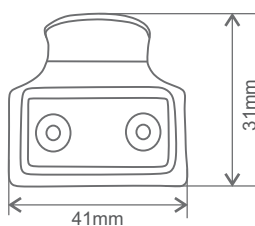

Referência	Dimensões	Acabamento
210I	41x31mm	Inox Polido

### Prendedor para Veneziana

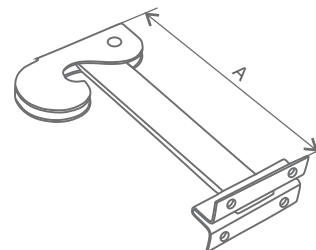

Referência	Dimensões	Acabamento
220MI	36mm	Inox Polido
222MI	80mm	Inox Polido

### Cremona

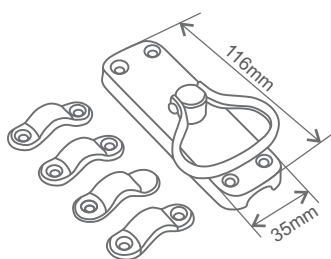

Referência	Dimensões	Acabamento
116I	116x35mm	Inox Polido

### Vara de Cremona

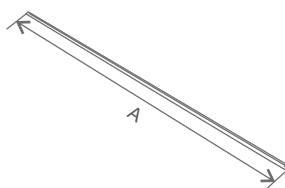

Referência	Dimensões	Acabamento
1200I	1200mm	Inox Polido
1500I	1500mm	Inox Polido

### Gancho de Rede

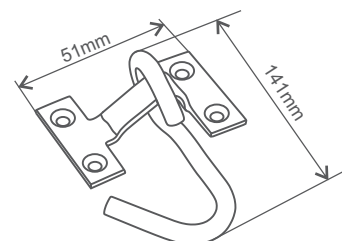

Referência	Dimensões	Acabamento
260IMC	51x141mm	Inox Polido

### Prendedor para porta Magnético

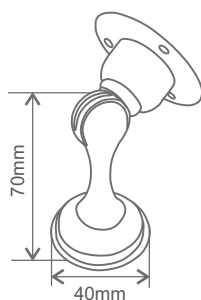

Referência	Dimensões	Acabamento
PRENDMAGC	70x40mm	Inox Polido

### Números (fixação dupla face)



Referência	
N0DFIPC, N1DFIPC, N2DFIPC, N3DFIPC, N4DFIPC, N5DFIPC, N6DFIPC, N7DFIPC, N8DFIPC	
Dimensões	Acabamento
125mmx85mm	Inox Polido

### Números (1-9)

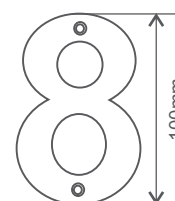

Referência	
N0IXC, N1IXC, N2IXC, N3IXC, N4IXC, N5IXC, N6IXC, N7IXC, N8IXC	
Dimensões	Acabamento
100mm	Inox Polido

### Porta Cadeado

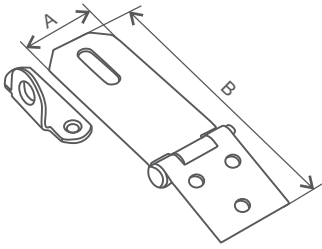

Referência	Dimensões	Acabamento
271I	25,2x60mm	Inox Polido
272I	47x140mm	Inox Polido

### Targeta

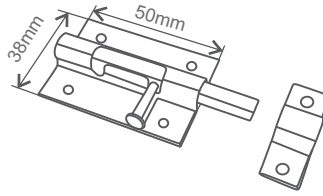

Referência	Dimensões	Acabamento
280I	50x38mm	Inox Polido

### Dobradiça Basculante (gonzo)

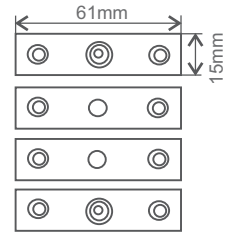

Referência	Dimensões	Acabamento
240I	61x15mm	Inox Polido

### Dobradiça Basculante (gonzo)

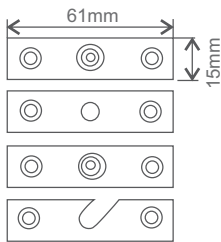

Referência	Dimensões	Acabamento
241I	61x15mm	Inox Polido

### Dobradiça Leme

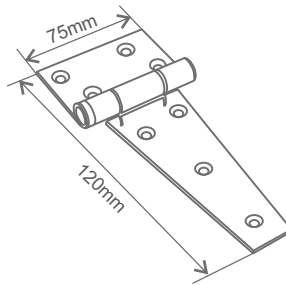

Referência	Dimensões	Acabamento
331C	75x120mm	Inox Polido

# PRODUTOS COMPLEMENTARES

A linha complementar da Synter foi criada para oferecer uma solução completa de controle, gerenciamento e segurança para o seu ambiente. Ela inclui fechaduras eletromagnéticas, catracas e barras antipânico.



LANÇAMENTO

# COMPLEMENTARES

Os produtos complementares são ideais para ambientes com grande fluxo de pessoas, como halls de entrada de edifícios, escolas, universidades e hospitais. Nesses locais, fechaduras eletromagnéticas, catracas e barras antipânico são essenciais para garantir um controle de acesso eficiente.

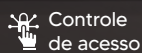
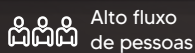

# FECHADURAS ELETROMAGNÉTICAS

Indicadas para o uso em esquadrias de vidro, alumínio ou pvc acionadas por controladoras de acesso. Indicação de uso de acordo com o modo de abertura da esquadria. Robustas podem ser utilizadas em portas pesadas.

LANÇAMENTO

## FECHADURAS SOLENOIDES EM INOX 304

FECHADURA SOLENOIDES N1



MODELO: 10.7777.CX01

Aplicação: Vidro/vidro

Material: Aço Inox 304

Tipo de Abertura: Abertura interna

Tipo de Acabamento: Escovado

Suporta mais de 1000 KGF

Com QR Code de instruções

FECHADURA SOLENOIDES N2



MODELO: 10.7788.CX01

Aplicação: Vidro/vidro

Material: Aço Inox 304

Tipo de Abertura: Abertura externa

Tipo de Acabamento: Escovado

Suporta mais de 1000 KGF

FECHADURA SOLENOIDES N3



MODELO: 10.7799.CX01

Aplicação: Vidro/Alvenaria

Material: Aço Inox 304

Tipo de Abertura: Abertura interna

Tipo de Acabamento: Escovado

Suporta mais de 1000 KGF

Acompanha gabarito para furação

LANÇAMENTO

# FECHADURAS SOLENOIDES EM INOX 304

## FECHADURA SOLENOIDES



MODELO: 10.7766.CX01

Aplicação: Vidro/vidro

Material: Aço Inox 304

Tipo de Abertura: Abertura interna

Tipo de Acabamento: Escovado

Suporta mais de 1000 KGF

Acompanha gabarito para furação

## FECHADURA SOLENOIDES



MODELO: 10.7755.CX01

Material: Aço Inox 304

Tipo de Abertura: Fechadura de embutir

Tipo de Acabamento: Escovado

Suporta mais de 1000 KGF

Acompanha gabarito para furação

LANÇAMENTO

# CATRACAS

MODELO: 10.3322.CX01

## Cenários de aplicação:

Metrô, estações, docas, atrações turísticas, locais de exposição, comunidades, fábricas, canteiros de obras, academias de ginástica, escritórios edifícios, bibliotecas escolares, controle de entrada e saída, controle de acesso, gestão de consumo, gestão de passagens especiais e controle de empresas e instituições.

## Principais vantagens:

- Acesso exclusivo para pessoas autorizadas;
- Notificação de entrada e saída;
- Coleta eficiente de dados;
- Maior confiabilidade no controle de público.



LANÇAMENTO

# CATRACAS

## Cenários de aplicação:

Metrôs, estações, docas, atrações turísticas, locais de exposição, comunidades, fábricas, canteiros de obras, academias de ginástica, escritórios edifícios, bibliotecas escolares, controle de entrada e saída, controle de acesso, gestão de consumo, gestão de passagens especiais e controle de empresas e instituições.



Material do chassi	SUS304 de aço inoxidável
Tamanho do chassi	1200*280*980mm(C*L*A)
Material da asa da porta	SUS304 de aço inoxidável
Largura da Passagem	≤550 mm
Tensão de entrada	110V~220V,50Hz
Velocidade de abertura	Mais rápido <0,5 segundos (configuração do usuário)
Velocidade de passagem	20-60 pessoas/minuto
Ambiente de uso	Interior exterior
Temperatura ambiente	25 C-70 C

## DIMENSÕES DO PRODUTO - CATRACA

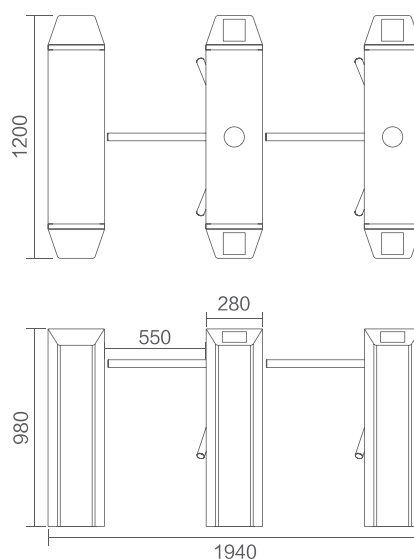



LANÇAMENTO

# BARRA ANTIPÂNICO PUSH



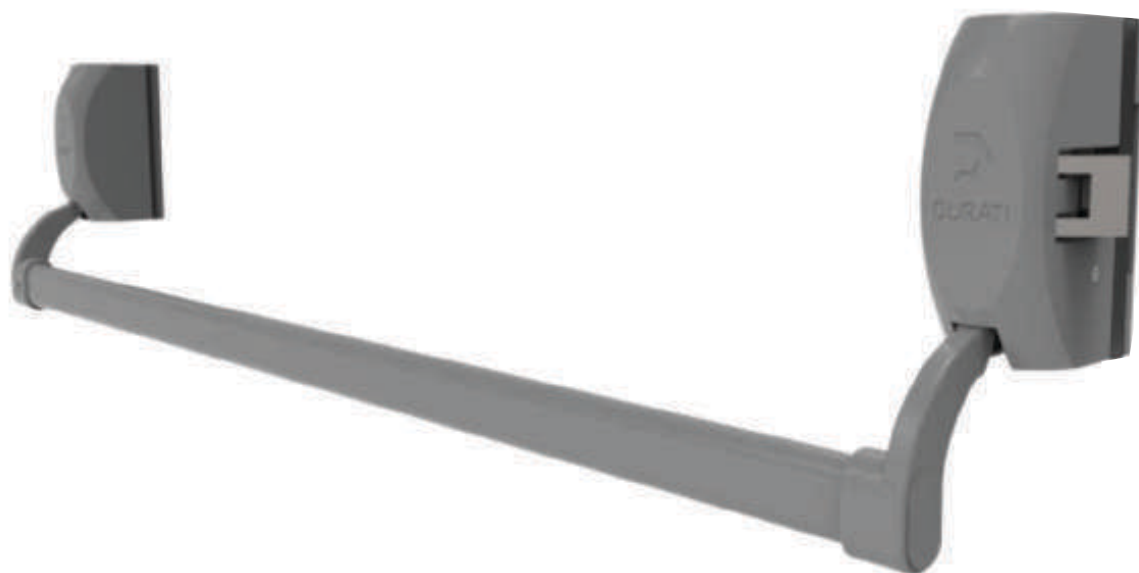



A linha de barras antipânico push possui alta resistência, é certificada conforme a norma ABNT NBR 11785, possui uma instalação simples e design inovador. É uma linha muito versátil, podendo ser aplicada em portas de vidro temperado e integradas com controles de acesso eletrônicos. Uma linha e muitas soluções.



Acabamentos   

## Características:

- Certificada conforme a norma ABNT NBR 11785;
- Reversível, podendo ser instalada em portas com os dois sentidos de abertura;
- Acionamento leve e silencioso;
- Resistência a corrosão;
- Acabamento de alto padrão;
- Embalagens individuais;
- Manual completo de instalação em português;
- Indústria Brasileira;
- Atende portas de até 250x130x8cm;
- Tubo de acionamento de 30x16x1200mm;
- Tampas e acabamento em pintura epóxi.

10.2244CX01	Barra Antip. Push C Horizontal	
10.2255CX01	Barra Antip. Push C Vertical	
10.2266CX01	Barra Antip. Push C Dupla Horiz./Vert.	
10.2277CX01	Barra Antip. Push F Horizontal	
10.2288CX01	Barra Antip. Push F Vertical	
10.2299CX01	Barra Antip. Push F Dupla Horiz./Vert.	

## DIMENSÕES DO PRODUTO - BARRA ANTIPÂNICO PUSH

### BARRA ANTIPÂNICO PUSH SIMPLES

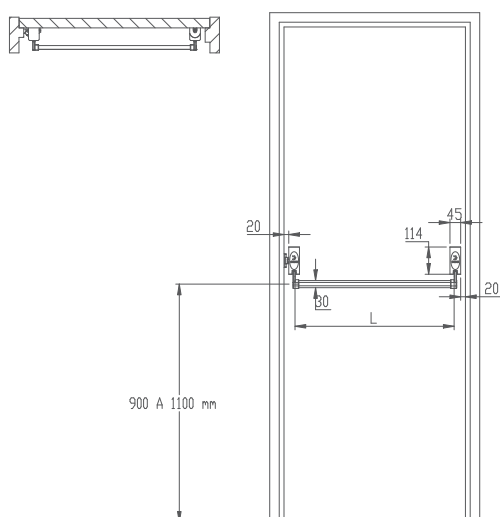

### BARRA ANTIPÂNICO PUSH SIMPLES COM HASTES E TRINCOS

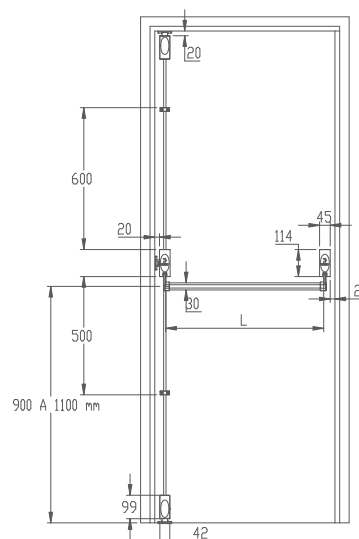

### BARRA ANTIPÂNICO PUSH DUPLA

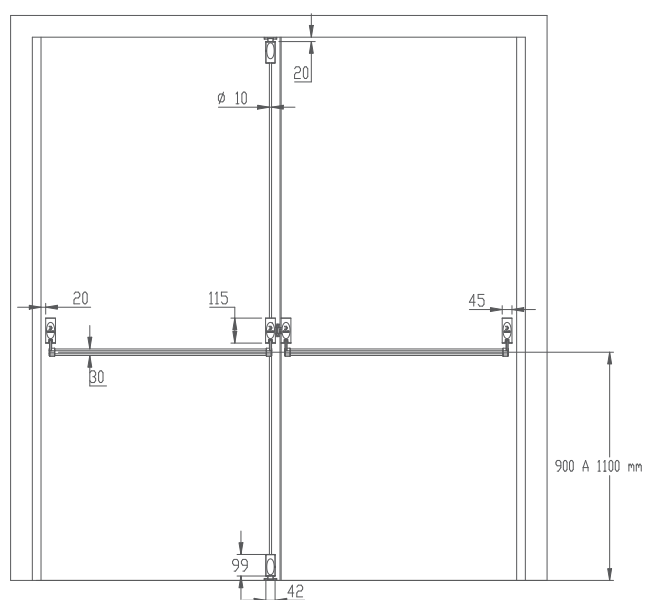

### ACESSO EXTERNO

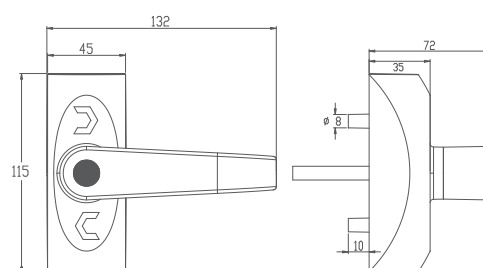

### SUPORE P/ BARRA ANTIPÂNICO

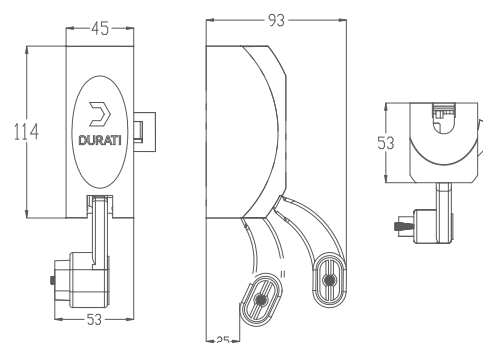

LANÇAMENTO

# BARRA ANTIPÂNICO TOUCH

A linha de barras antipânico Touch possui alta robustez, design atraente que garante durabilidade, estética e conforto no acionamento.



## CARACTERÍSTICAS:

- Atende a NRB 11785;
- Indicada para portas corta-fogo, madeira ferro, PVC e alumínio;
- Reversível, podendo ser instalada em portas com os dois sentidos de abertura;
- Atende portas de até 2485mm (H) x 1300mm (L) x 50mm (E)
- Acabamento leve e silencioso;
- Resistência a corrosão;
- Acabamento de alto padrão;
- Embalagens individuais;
- Manual completo de instalação em português;
- Indústria brasileira;
- Tampas e acabamento em pintura epóxi.

## ACABAMENTOS ●

10.2211CX01

Barra Antip. Touch Horizontal F



10.2212CX01

Barra Antip. Touch Vertical F



As barras antipânico Touch podem ser utilizadas em portas de uma folha (simples) ou de duas folhas (duplas) nas versões vertical ou horizontal.

LANÇAMENTO

## ACESSÓRIOS OPCIONAIS

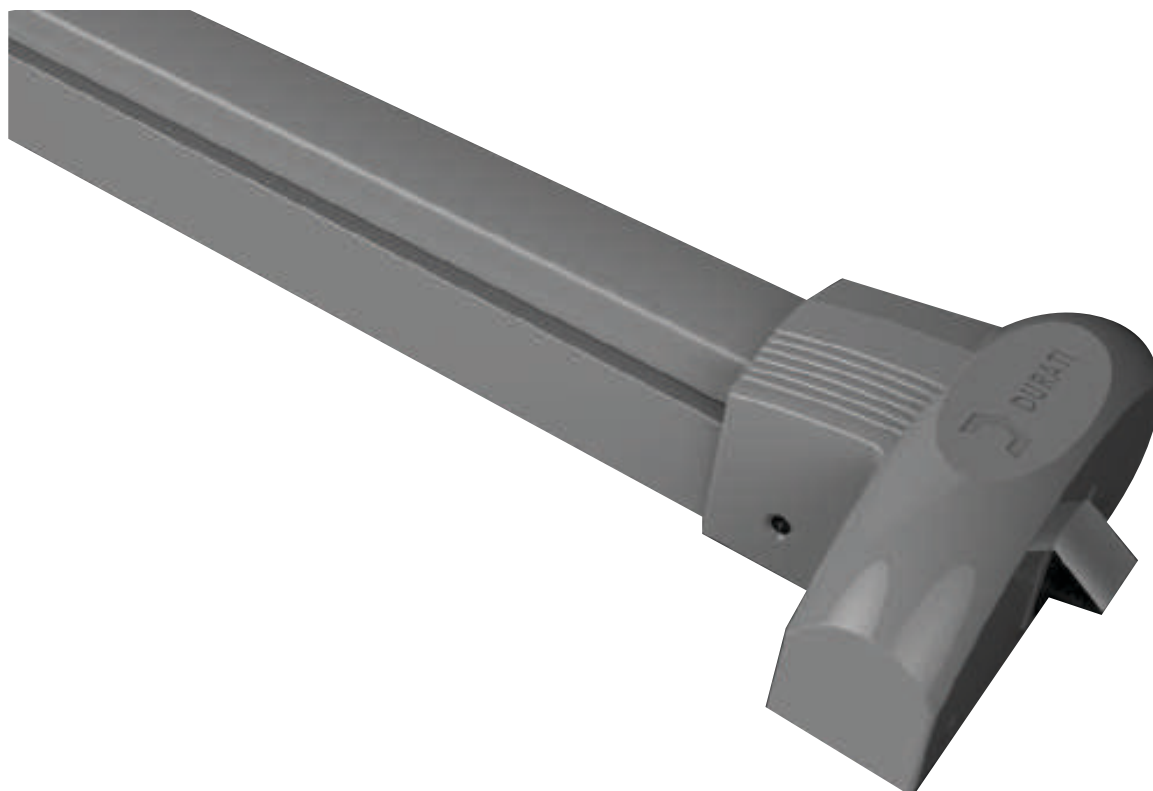

### MICROSWITCH INTEGRADO

A linha de barras antipânico Touch podem ser fornecidas com micro switch integrado. Este acessório possibilita a abertura de fechaduras eletromagnéticas quando a barra antipânico é acionada e a integração da barra antipânico com sistemas de controle de acesso ou alarmes.

10.2210CX01

Barra Antip. Durati Touch F Horizontal C/switch



10.2209CX01

Barra Antip. Durati Touch F Vertical C/switch



DIMENSÕES DO PRODUTO - **ACESSÓRIOS E OPCIONAIS**

BARRA ANTIPÂNICO TOUCH HORIZONTAL

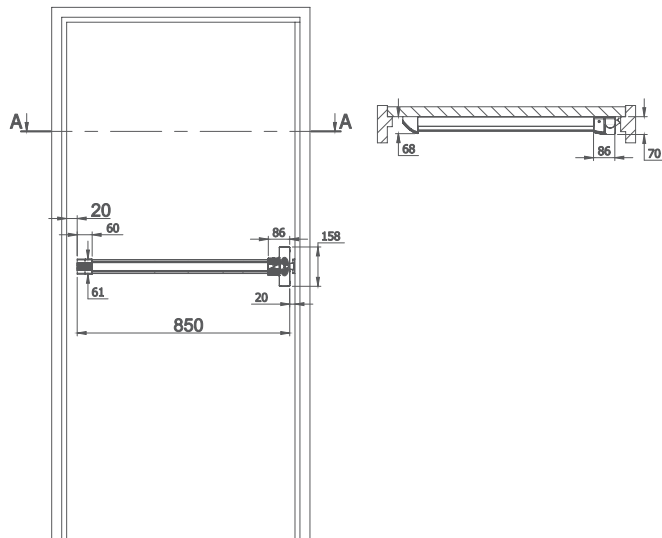

BARRA ANTIPÂNICO TOUCH VERTICAL

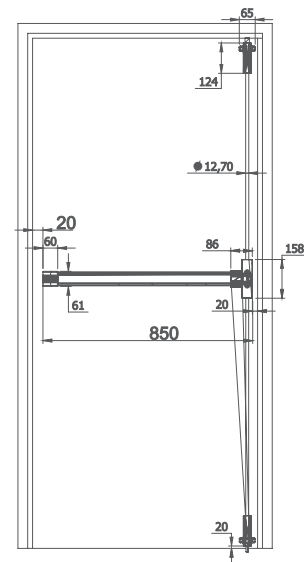

BARRA ANTIPÂNICO TOUCH DUPLA

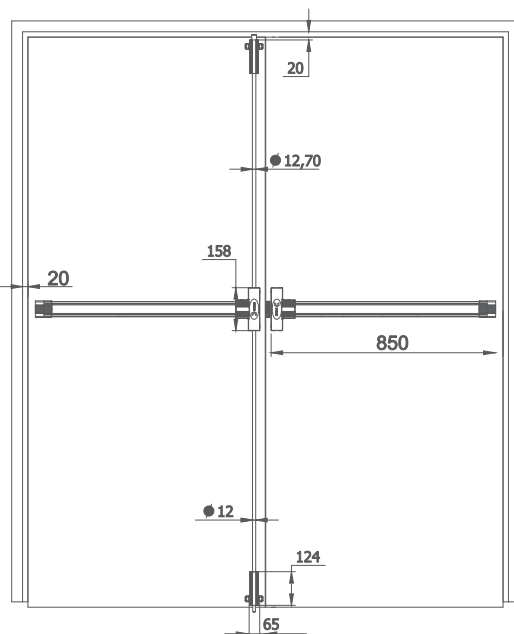

ACESSO EXTERNO

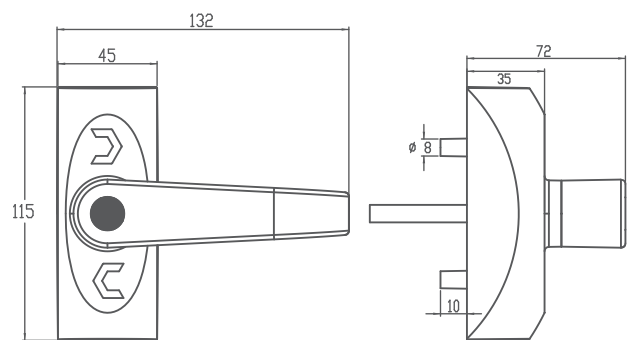



 **synter**

✉ [comercial@synter.com.br](mailto:comercial@synter.com.br) | ☎ +55 48 9932-0492

Rodovia Gabriel Arns, 5572 Caixa Postal 15  
Cep: 88850-000 - Forquilha - Santa Catarina  
+55 (48) 3941 1100