

 **synter**

The logo icon consists of a stylized 'S' shape formed by four white squares arranged in a 2x2 grid, with the top-right square missing.

Soluções Inteligentes

CATÁLOGO 2026

Fornecer soluções duráveis e seguras que **simplificam e conectam a vida das pessoas** é o nosso propósito.

Índice

Soluções Inteligentes	04
Synter Soluções	04
Produtos Inteligentes	05
Fechaduras Inteligentes	05
Controladoras de Acesso	09
Fechaduras Mecânicas	11
Inox Prime.....	11
Unic Inox	13
Acessibilidade Inox.....	15
Flex.....	16
Pop.....	16
Gol.....	17
Auxiliares.....	21
Componentes.....	23
Puxadores	25
Dobradiças	27
Inox 304 Premium	27
Máxima Inox	28
Aço Basic	28
Ferragens e Acessórios	32

Synter Soluções

Um ecossistema completo para controle de acesso

Somos a Synter, uma indústria brasileira fundada em 1991, em Forquilha (SC), especializada no desenvolvimento de soluções em controle de acesso para a construção civil, unindo durabilidade, resistência e confiança. Nossa trajetória é marcada pela excelência técnica e pelo domínio completo do processo produtivo, consolidado pelo trabalho com aço inox e, desde 2005, pela fabricação própria de fechaduras residenciais.

Ao longo dos anos, construímos uma marca sólida, sustentada por inovação contínua, parcerias duradouras e um compromisso permanente com a qualidade. Acompanhando a evolução do mercado, expandimos nossa atuação para o universo digital com a Synter Digital, integrando tecnologia às fechaduras. Em 2023, esse movimento se consolidou com o lançamento do Aplicativo Synter e, na sequência, o desenvolvimento da Plataforma Synter – ambos 100% desenvolvidos no Brasil.

Hoje, somos um ecossistema completo em controle de acesso. Synter Soluções integra indústria, hardware, software e conectividade para oferecer soluções inteligentes que conectam pessoas, espaços e o futuro.

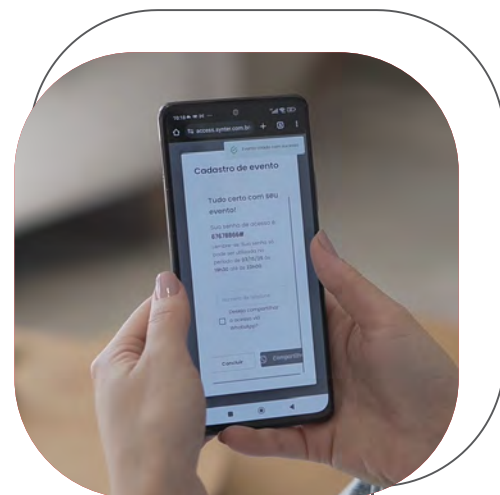

Plataforma Synter - controle e gerenciamento de acessos
Aplicativo e Web



Produtos Inteligentes
Fechaduras digitais e controladoras de acesso



Fechaduras Mecânicas
Dobradiças, puxadores e ferragens



Synter Soluções
Parque industrial • Forquilha (SC)

PRODUTOS INTELIGENTES

Com design moderno e sofisticado, as fechaduras e controladoras de acesso Synter transformam a forma de acessar lares e negócios. Controle seus ambientes com praticidade e escolha tecnologias como reconhecimento facial, biometria, senhas numéricas, TAG ou o aplicativo Synter.

FECHADURAS DIGITAIS

Eris S2 FACE ID

Ref.: X99913FACEBM/60Q



Formas de Abertura



Aplicativo Synter



Leitor biométrico
(Até 100 registros)



Senha numérica
(250 registros)



TAGs*
(1000 registros)



Chave de Segurança



Abertura com Reconhecimento Facial
(50 registros)

Conectividade



Wifi
(com o gateway)



Bluetooth

Tipo de Instalação



Embutir



Espessura da Porta

40 ~ 120mm

Aplicação



Ambiente Externo e Interno*



Fonte de Alimentação

Bateria Recarregável

Diferenciais



IP65*



Modo Privacidade



Compatível com Alexa
(com o gateway)



Máquina de Alta Segurança

*Tag's- Compatível com Tag's RFID 13.56 MHz;

*Ambiente externo e interno- sem exposição direta ao sol ou maresia;

*IP65- Proteção total contra poeira e jatos de água de baixa pressão vindos de qualquer direção.

Venus S3 PRO

Ref.: X99914ABBCSBM/60Q

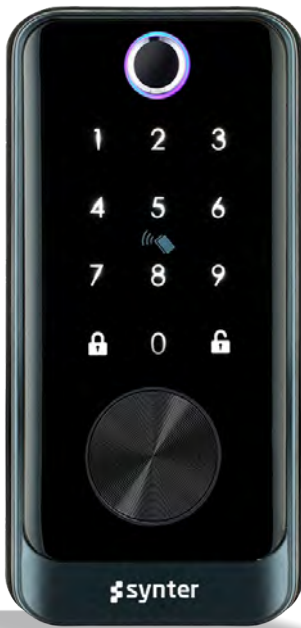

Formas de Abertura



Aplicativo
Synter



Leitor biométrico
(Até 100 registros)



Wifi
(com o gateway)



Senha numérica
(500 registros de senhas
divididos com TAGs)



TAGs*
(500 registros de TAGs
divididos com senhas)



Bluetooth



Chave de
Segurança

Fonte de Alimentação



Alimentação
por Pilhas

Tipo de Instalação



Embutir

Espessura da Porta



35 ~ 55mm

Aplicação



Ambiente
Externo e Interno*



Portas de giro com
uso de Puxador

Diferenciais



IP65*



Modo
Privacidade



Compatível com
Alexa
(com o gateway)

*Tag's- Compatível com Tag's RFID 13.56 MHz;

*Ambiente externo e interno- sem exposição direta ao sol ou maresia;

*IP65- Proteção total contra poeira e jatos de água de baixa pressão vindos de qualquer direção.

Syrius S3 MAX

Ref.: X93013ABBCSBM/60Q



Formas de Abertura



Aplicativo
Synter



Leitor biométrico
(Até 100 registros)



Senha numérica
(500 registros de senhas
divididos com TAGs)



TAGs*
(500 registros de TAGs
divididos com senhas)



Chave de
Segurança

Conectividade



Wifi
(com o gateway)



Bluetooth

Fonte de Alimentação



Alimentação
por Pilhas

Tipo de Instalação



Embutir

Espessura da Porta



40 ~ 80mm

Aplicação



Ambiente
Externo e Interno*



Portas de Madeira
de Grande Porte

Diferenciais



IP55*



Modo
Privacidade



Máquina de
Alta Segurança



Compatível com Alexa
(com o gateway)

*Tag's- Compatível com Tag's RFID 13.56 MHz;

*Ambiente externo e interno- sem exposição direta ao sol ou maresia;

*IP55- Proteção parcial contra poeira e jatos de água de baixa pressão vindos de qualquer direção.

LANÇAMENTO

Syrius S2 PRO NEO

Ref. com Wi-Fi integrado: X93015ABBCSBM/55Q

Ref. sem Wi-Fi: X93014ABBCSBM/55Q

Formas de Abertura



Aplicativo Synter



Leitor biométrico (Até 100 registros)



Senha numérica (total 300 registros)



TAGs* (total 300 registros)



Chave de Segurança

Conectividade



Wifi (Disponível com Wi-Fi integrado ou via gateway)



Bluetooth

Fonte de Alimentação



Alimentação por Pilhas

Tipo de Instalação



Embutir

Espessura da Porta



35 ~ 55mm

Aplicação



Ambiente Interno*

Diferenciais



Compatível com Alexa (Necessário para a versão sem Wi-Fi integrado)



LANÇAMENTO

Syrius S3 PRO

Ref.: X93012ABBCSBM/60Q

Formas de Abertura



Aplicativo Synter



Leitor biométrico (Até 100 registros)



Senha numérica (500 registros de senhas divididos com TAGs)



TAGs* (500 registros de TAGs divididos com senhas)



Chave de Segurança

Conectividade



Wifi (com o gateway)



Bluetooth

Fonte de Alimentação



Alimentação por Pilhas

Tipo de Instalação



Embutir

Espessura da Porta



35 ~ 55mm

Aplicação



Ambiente Externo e Interno*

Diferenciais



IP55*



Compatível com Alexa (com o gateway)



*Tag's- Compatível com Tag's RFID 13.56 MHz;

*Ambiente externo e interno- sem exposição direta ao sol ou maresia;

*IP55- Proteção parcial contra poeira e jatos de água de baixa pressão vindos de qualquer direção.

LANÇAMENTO PARA PORTA DE PVC E ALUMÍNIO

Vega FACE ID



Formas de Abertura



Aplicativo Synter



Leitor biométrico
(Até 100 registros)



Wifi
(com o gateway)



Senha numérica
(total 250 registros)



TAGs*
(total 1000 registros)



Bluetooth



Abertura com Reconhecimento Facial
(50 registros)



Chave de Segurança

Fonte de Alimentação



Bateria Recarregável

Tipo de Instalação



Embutir

Espessura da Porta



40 ~ 110mm

Aplicação



Ambiente Externo e Interno*

Diferenciais



IP65*



Compatível com Alexa
(com o gateway)

*Tag's- Compatível com Tag's RFID 13.56 MHz;

*Ambiente externo e interno- sem exposição direta ao sol ou maresia;

*IP65- Proteção total contra poeira e jatos de água de baixa pressão vindos de qualquer direção.

LANÇAMENTO PARA PORTA DE PVC E ALUMÍNIO

Lyra PRO



Formas de Abertura



Aplicativo Synter



Leitor biométrico
(Até 100 registros)



Wifi
(com o gateway)



Senha numérica
(Até 250 registros)



TAGs*
(Até 1000 registros)



Bluetooth



Chave de Segurança

Fonte de Alimentação



Alimentação por Pilhas

Tipo de Instalação



Embutir

Espessura da Porta



40 ~ 110mm

Aplicação



Ambiente Externo e Interno*

Diferenciais



IP65*



Compatível com Alexa
(com o gateway)

*Tag's- Compatível com Tag's RFID 13.56 MHz;

*Ambiente externo e interno- sem exposição direta ao sol ou maresia;

*IP65- Proteção total contra poeira e jatos de água de baixa pressão vindos de qualquer direção.

DESENHOS TÉCNICOS - FECHADURAS DIGITAIS

Eris S2 FACE ID

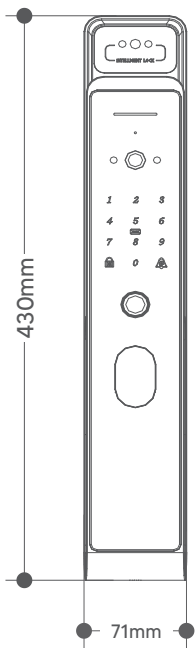

Venus S3 PRO

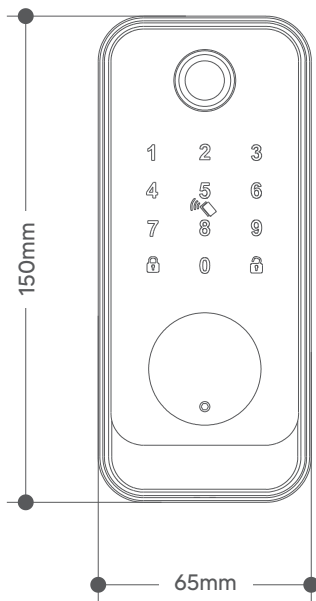

Syrius S3 MAX

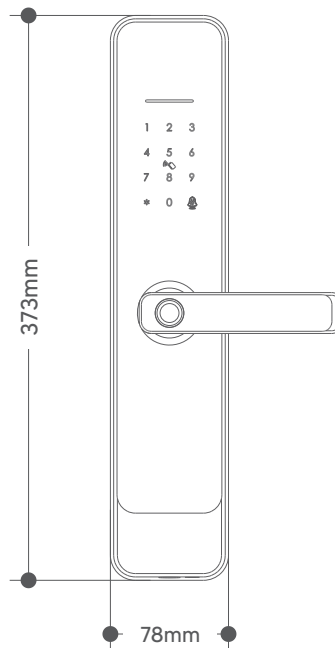

Syrius S2 PRO NEO

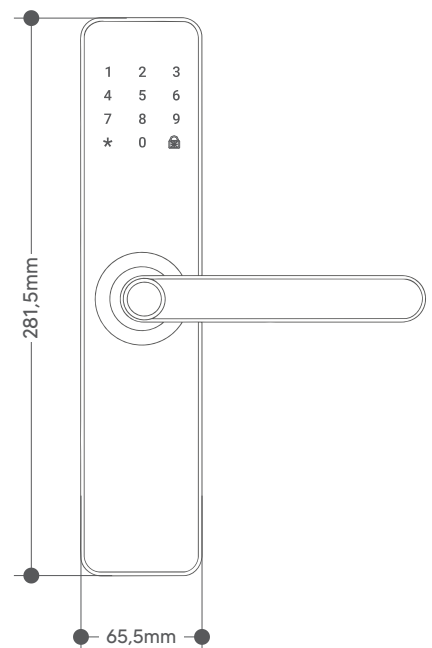

Syrius S3 PRO

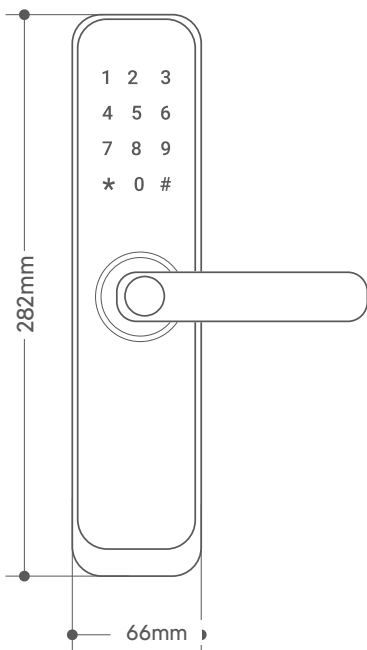

Vega FACE ID

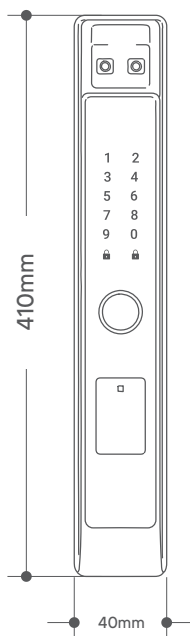

Lira PRO

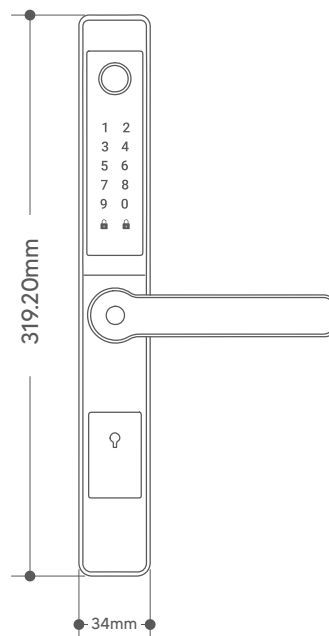

Controladora de Acesso S2 Pro

Ref.: XCONTS2PRO



Formas de Abertura



Aplicativo Synter



Leitor biométrico
(Até 100 registros)



Sobrepor



Senha numérica
(total 500 registros)



TAGs*
(total 2000 registros)

Conectividade



Wifi
(com o gateway)



Bluetooth



Fonte de Alimentação 12V

Aplicação



Ambiente Externo e Interno*



Consultar compatibilidade com sistemas de fechamento

Diferenciais



IP67*

*Tag's- Compatível com Tag's RFID 13.56 MHz;

*Ambiente externo e interno- sem exposição direta ao sol ou maresia;

*IP67- Proteção total contra poeira e proteção contra imersão temporária em água.

Kit para aplicação sugerido:



Fechadura eletroimã



Suporte para fechadura eletroimã



Botão de sobrepor



Fonte 12 Volts e 5 Amperes

Controladora de Acesso S2 QR

Ref.: XCONTS2QR



Formas de Abertura



Aplicativo Synter



Abertura com QR Code
(ilimitado)



Sobrepor



Senha numérica
(total 500 registros)



TAGs*
(total 2000 registros)

Conectividade



Wifi
(com o gateway)



Bluetooth



Fonte de Alimentação 12V

Aplicação



Ambiente Externo e Interno*



Consultar compatibilidade com sistemas de fechamento

Diferenciais



IP67*

*Tag's- Compatível com Tag's RFID 13.56 MHz;

*Ambiente externo e interno- sem exposição direta ao sol ou maresia;

*IP67- Proteção total contra poeira e proteção contra imersão temporária em água.

Kit para aplicação sugerido:



Fechadura eletroimã



Suporte para fechadura eletroimã



Botão de sobrepor



Fonte 12 Volts e 5 Amperes

Controladora de Acesso S2 Face ID

Ref.: XCONTS2FACEID

Formas de Abertura



Aplicativo Synter



Abertura com QR Code (ilimitado)



TAGs* (total 15000 registros)



Leitor biométrico (Até 10000 registros)



Senha numérica (total 15000 registros)



Abertura com Reconhecimento Facial

Tipo de Instalação



Sobrepor

Conectividade



Ethernet (rede cabeada)

Fonte de Alimentação



Fonte de Alimentação 12V

Aplicação



Ambiente Interno*



Consultar compatibilidade com sistemas de fechamento

Diferenciais



Reconhecimento facial em tempo real



Velocidade de reconhecimento de < 0.2 segundos



Reconhecimento com máscara



Distância de reconhecimento configurável (0.5 a 2.5 metros)



Alarme de arrombamento



*Tag's- Compatível com Tag's RFID 13.56 MHz;

*Ambiente interno- sem exposição direta ao sol ou maresia.

Kit para aplicação sugerido:



Fechadura eletroimã



Suporte para fechadura eletroimã



Botão de sobrepor



Fonte 12 Volts e 5 Amperes

DESENHOS TÉCNICOS CONTROLADORAS DE ACESSO

Controladora de Acesso S2 PRO e QR

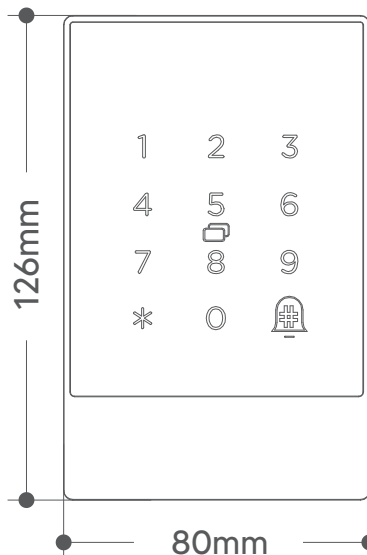

Controladora de Acesso S2 FACE ID

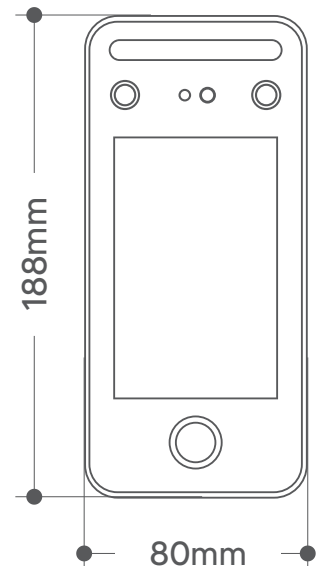

FECHADURAS MECÂNICAS

As fechaduras são elementos de decoração em todos os ambientes, além de ser um dos principais dispositivos de segurança presentes em todos os projetos. A preocupação com a ergonomia, durabilidade e custo-benefício são os fatores determinantes para escolher o modelo certo. Combine com máquinas e cilindros adequados à sua necessidade e forme o conjunto ideal.



INOX PRIME

Resistência à maresia, design diferenciado e alta durabilidade: esses são apenas alguns dos pontos fortes da nossa linha mais vendida

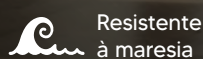
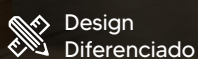
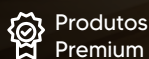
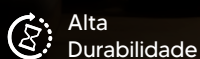

Acqua Max Inox

Ref.: X720081
 Roseta: 08 - Máquina: 55mm
 Função: Ext/Int/Ban
 Acabamento: Polido



Crispux Max Inox

Ref.: X731131
 Roseta: 13 - Máquina: 55mm
 Função: Ext/Int/Ban
 Acabamento: Polido



Luck Inox

Ref.: X730091
 Roseta: 09 - Máquina: 55mm
 Função: Ext/Int/Ban
 Acabamento: Polido / Escovado / Preto



Luck Inox

Ref.: X730011
 Roseta: 01 - Máquina: 55mm
 Função: Ext/Int/Ban
 Acabamento: Polido / Escovado / Preto



Navis Inox

Ref.: X724011
 Roseta: 01 - Máquina: 55mm
 Função: Ext/Int/Ban
 Acabamento: Polido / Escovado / Preto



Navis Inox

Ref.: X724041
 Roseta: 04 - Máquina: 55mm / 40mm
 Função: Ext/Int/Ban
 Acabamento: Polido / Escovado / Preto



Navis Inox

Ref.: X724091
 Roseta: 09 - Máquina: 55mm
 Função: Ext/Int/Ban
 Acabamento: Polido / Escovado / Preto

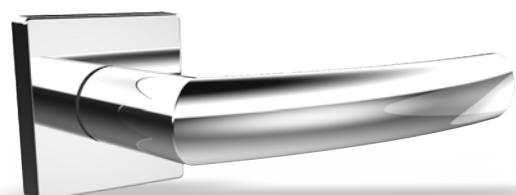

Navis Inox

Ref.: X724071
 Roseta: 07 - Máquina: 55mm / 40mm
 Função: Ext/Int/Ban
 Acabamento: Polido / Escovado / Preto



Polo Max Inox

Ref.: X73315I
 Roseta: 15 - Máquina: 55mm
 Função: Ext/Int/Ban
 Acabamento: Polido



Mola de reforço integrada

Star Max Inox

Ref.: X73214I
 Roseta: 14 - Máquina: 55mm
 Função: Ext/Int/Ban
 Acabamento: Polido



Mola de reforço integrada

Star Inox

Ref.: X72809I
 Roseta: 09 - Máquina: 55mm
 Função: Ext/Int/Ban
 Acabamento: Polido / Escovado / Preto



Star Inox

Ref.: X72807I
 Roseta: 07 - Máquina: 55mm / 40mm
 Função: Ext/Int/Ban
 Acabamento: Polido / Escovado / Preto



Alta Durabilidade

Produtos Premium

Indicado para ambientes internos e externos

Design Diferenciado

Resistente à maresia

Utilização em esquadrias de madeira em geral

Acabamentos com excelência

Maçanetas, rosetas, falsa testa e contra testa em aço inoxidável;
 Disponibilidade de cilindro 62mm
 Guarda-pós em nylon branco para acabamento premium

UNIC INOX

Design sofisticado e minimalista, com a versatilidade de máquinas e acabamentos em diversos formatos. Feita para compor com leveza e elegância qualquer ambiente.

Alta Durabilidade

Resistente à maresia

Champion Inox

Ref.: X72109I
 Roseta: 09 - Máquina:55mm
 Função: Ext/Int/Ban
 Acabamento: Polido / Escovado / Preto



Champion Inox

Ref.: X72107I
 Roseta: 07 - Máquina: 55mm / 40mm
 Função: Ext/Int/Ban
 Acabamento: Polido / Escovado / Preto



Marine Inox

Ref.:X72209I
 Roseta: 09 - Máquina:55mm
 Função: Ext/Int/Ban
 Acabamento: Polido / Preto



Marine Inox

Ref.: X72207I
 Roseta: 07 - Máquina:55mm / 40mm
 Função: Ext/Int/Ban
 Acabamento: Polido / Preto



Marine Inox

Ref.: X72201I
 Roseta: 01 - Máquina: 55mm
 Função: Ext/Int/Ban
 Acabamento: Polido / Preto

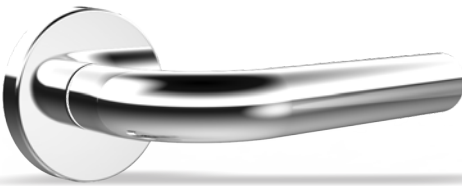

Marine Inox

Ref.: X72204I
 Roseta: 04 - Máquina: 55mm / 40mm
 Função: Ext/Int/Ban
 Acabamento: Polido / Preto



Marine II Inox

Ref.: X72909I
 Roseta: 09 - Máquina: 55mm
 Função: Ext/Int/Ban
 Acabamento: Escovado



Marine II Inox

Ref.: X72907I
 Roseta: 07 - Máquina: 55mm / 40mm
 Função: Ext/Int/Ban
 Acabamento: Escovado



Marine II Inox

Ref.: X72901I
 Roseta: 01 - Máquina: 55mm
 Função: Ext/Int/Ban
 Acabamento: Escovado



Marine II Inox

Ref.: X72904I
 Roseta: 04 - Máquina: 55mm / 40mm
 Função: Ext/Int/Ban
 Acabamento: Escovado



Navis II Inox

Ref.: X723011
 Roseta: 01 - Máquina: 55mm
 Função: Ext/Int/Ban
 Acabamento: Polido / Escovado / Preto

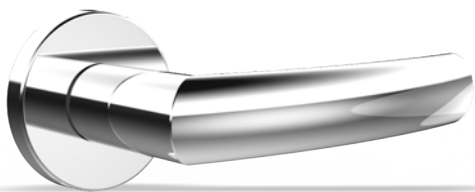

Navis II Inox

Ref.: X723041
 Roseta: 04 - Máquina: 55mm / 40mm
 Função: Ext/Int/Ban
 Acabamento: Polido / Escovado / Preto



Navis II Inox

Ref.: X723091
 Roseta: 09 - Máquina: 55mm
 Função: Ext/Int/Ban
 Acabamento: Polido / Escovado / Preto

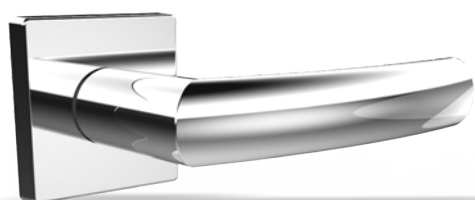

Navis II Inox

Ref.: X723071
 Roseta: 07 - Máquina: 55mm / 40mm
 Função: Ext/Int/Ban
 Acabamento: Polido / Escovado / Preto

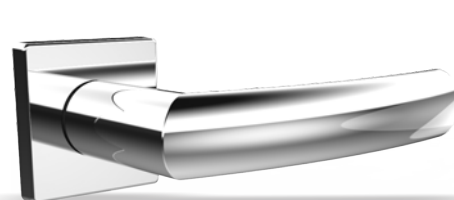

Acabamentos com excelência

Maçanetas, rosetas, falsa testa e contra testa em aço inoxidável;
 Disponibilidade de cilindro 62mm.

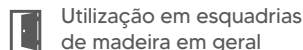
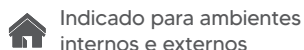

ACESSIBILIDADE INOX

Indicado para ambientes hospitalares

Ceci Inox

Ref.: X741011
 Roseta: 01 - Máquina: 55mm
 Função: Ext/Int/Ban
 Acabamento: Escovado

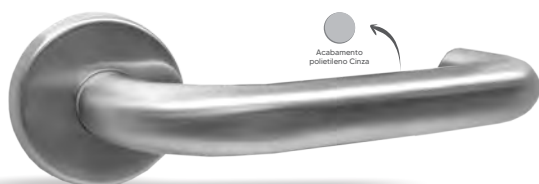

Acabamento polietileno Cinza

Ceci Inox

Ref.: X741101
 Roseta: 10 - Máquina: 55mm
 Função: Ext/Int/Ban
 Acabamento: Escovado



Acabamento polietileno Cinza

Barra de apoio Inox

Ref.: XBARRA600 / XBARRA400
 Tamanho: 400mm / 600mm
 Acabamento: Polido



Com Suportes Fixos



FLEX

A linha Flex reúne fechaduras em zamak que aliam durabilidade, design e versatilidade. Com diversos modelos, adapta-se a diferentes estilos e ambientes, garantindo qualidade e elegância.

Indicado para ambientes internos e externos com restrição

Utilização em esquadrias de madeira em geral

Não resistente à maresia

Glorian Zamak

Ref.: X51601I
Roseta: 01 - Máquina: 55mm
Função: Ext/Int/Ban
Acabamento: Cromado / Preto

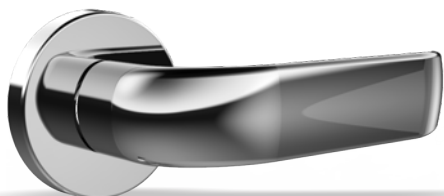

Glorian Zamak

Ref.: X51604I
Roseta: 04 - Máquina: 55mm / 40mm
Função: Ext/Int/Ban
Acabamento: Cromado / Preto



Olympia Zamak

Ref.: X51509I
Roseta: 09 - Máquina: 55mm
Função: Ext/Int/Ban
Acabamento: Cromado / Preto

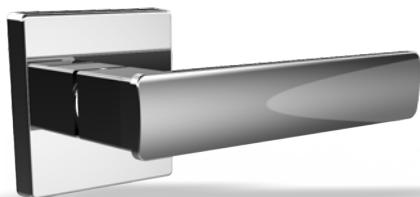

Olympia Zamak

Ref.: X51507I
Roseta: 07 - Máquina: 55mm / 40mm
Função: Ext/Int/Ban
Acabamento: Cromado / Preto

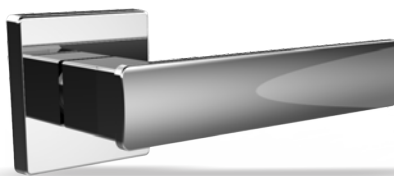

Acabamentos com excelência

Espelhos, rosetas, falsa testas e contra testa em aço inoxidável; Disponibilidade de cilindro 62mm.

POP

Uma solução funcional e acessível para residências, com design contemporâneo que une estilo e praticidade.

Indicado para ambientes internos e externos com restrição

Utilização em esquadrias de madeira em geral

Não resistente à maresia

Stillus Zamak

Ref.: X21104I
Roseta: 04 - Máquina: 55mm / 40mm
Função: Ext/Int/Ban
Acabamento: Cromado

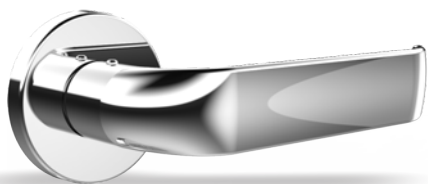

Stillus Zamak

Ref.: X21107I
Roseta: 07 - Máquina: 55mm / 40mm
Função: Ext/Int/Ban
Acabamento: Cromado

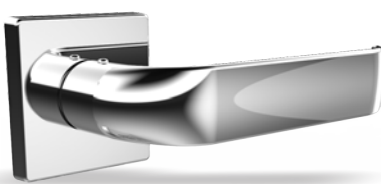

Stillus Zamak

Ref.: X21105I
Roseta: 05 - Máquina: 55mm / 40mm
Função: Ext/Int/Ban
Acabamento: Cromado





Acabamentos com excelência

Espelhos, rosetas, falsa testas e contra testa em aço inoxidável; Disponibilidade de cilindro 62mm.

GOL

Combinando funcionalidade e preço acessível, ela conquista aqueles que buscam segurança sem comprometer a qualidade.

 Indicado para ambientes internos e externos com restrição

 Utilização em esquadrias de madeira em geral

 Não resistente à maresia

Gol Zamak

Ref.: X110041
Roseta: 04 - Máquina: 40mm
Função: Ext/Int/Ban
Acabamento: Cromado

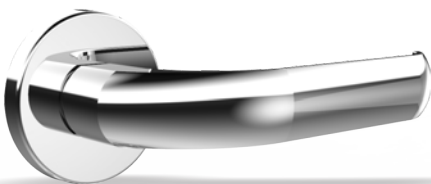

Gol Zamak

Ref.: X110061
Roseta: 06 - Máquina: 40mm
Função: Ext/Int/Ban
Acabamento: Cromado

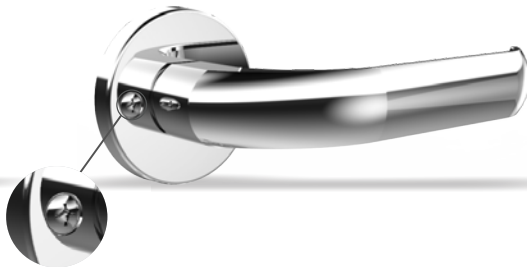

Gol Zamak

Ref.: X110051
Roseta: 05 - Máquina: 40mm
Função: Ext/Int/Ban
Acabamento: Cromado



Acabamentos com excelência | Espelhos, rosetas, falsa testa e contra testa em aço inoxidável; Disponibilidade de cilindro 62mm.

DIMENSÕES DOS PRODUTOS - LINHA INOX PRIME

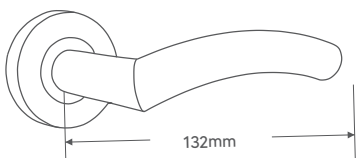

Acqua 08 - Redonda Grande

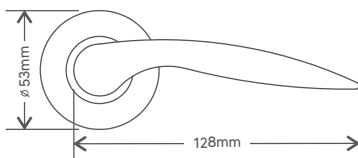

Crispus Max 10 - Redonda Grande

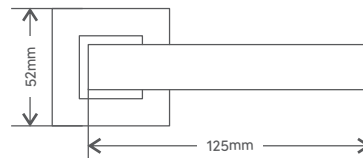

Star Max 10 - Quadrada Grande

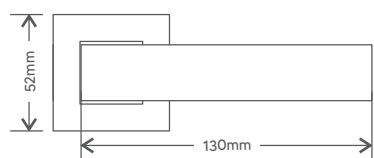

Polo Max 11 - Quadrada Grande

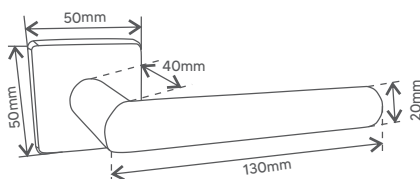

Luck 09 - Quadrada Grande

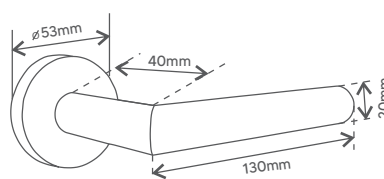

Luck 01 - Redonda Grande

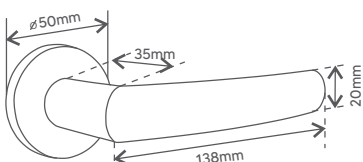

Navis 01 - Redonda Grande

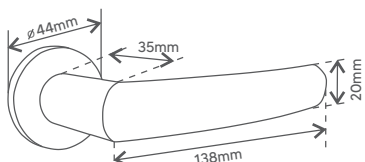

Navis 04 - Redonda Pequena

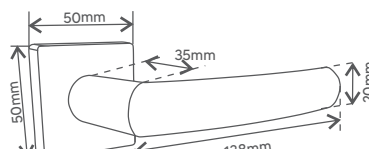

Navis 09 - Quadrada Grande

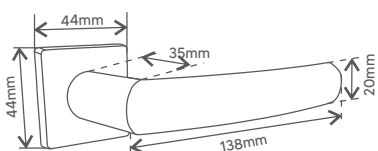

Navis 07 - Quadrada Pequena

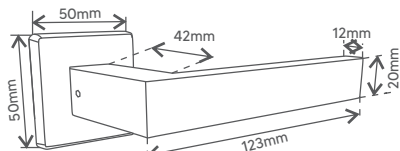

Star 09 - Quadrada Grande

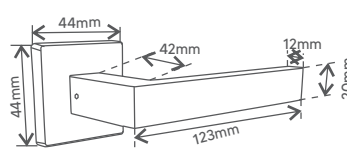

Star 07 - Quadrada Pequena

DESENHOS TÉCNICOS - LINHA UNIC INOX

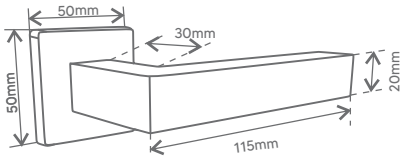

Champion 09 - Quadrada Grande

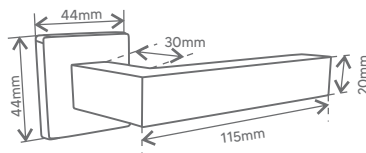

Champion 07 - Quadrada pequena

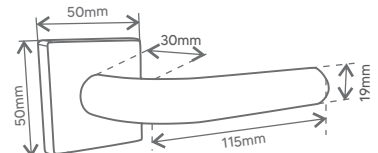

Marine 09 - Quadrada Grande

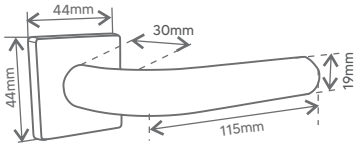

Marine 07 - Quadrada pequena

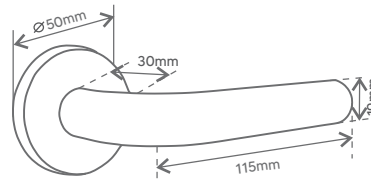

Marine 01 - Redonda Grande

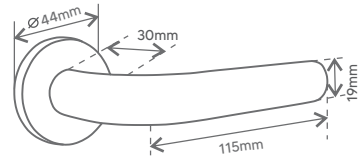

Marine 04 - Redonda pequena

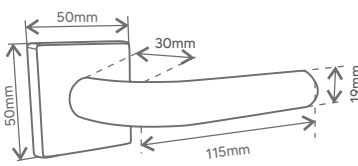

Marine Color 09 - Quadrada Grande

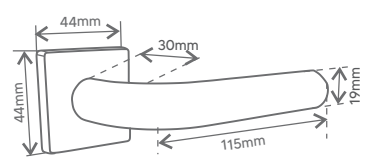

Marine Color 07 - Quadrada pequena

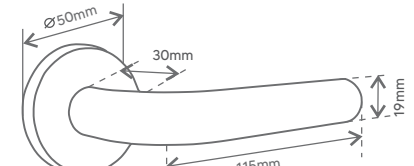

Marine Color 01 - Redonda Grande

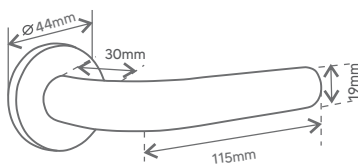

Marine Color 04 - Redonda pequena

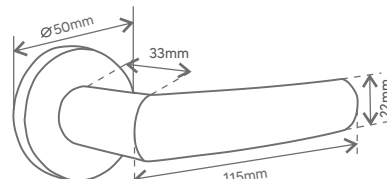

Navis II 01 - Redonda Grande

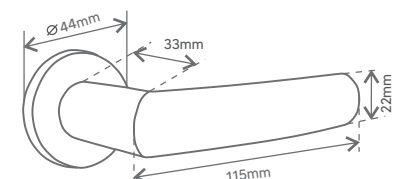

Navis II 04 - Redonda pequena

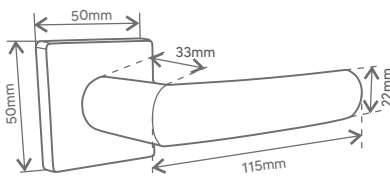

Navis II 09 - Quadrada Grande

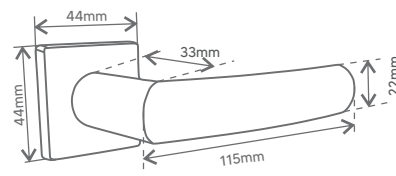

Navis II 07 - Quadrada pequena

DESENHOS TÉCNICOS - LINHA ACESSIBILIDADE INOX

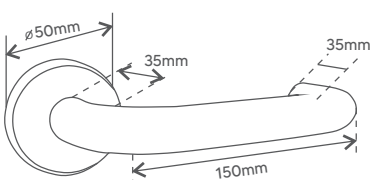

Ceci 01 - Redonda Grande

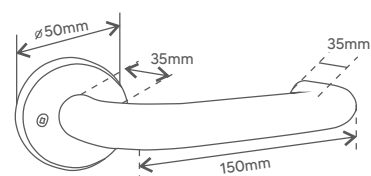

Ceci 10 - Redonda Grande
c/ parafuso aparente

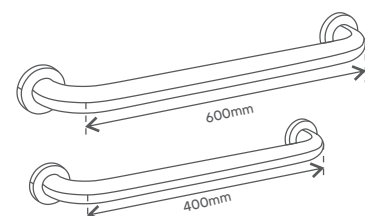

Barra 600mm ou 400mm

DESENHOS TÉCNICOS - LINHA FLEX

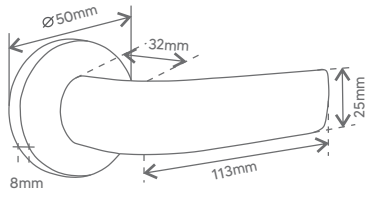

Glorian 01 - Redonda Grande

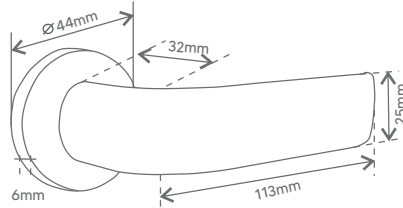

Glorian 04 - Redonda pequena

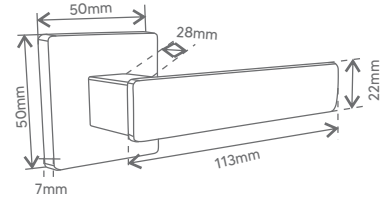

Olympia 09 - Quadrada Grande

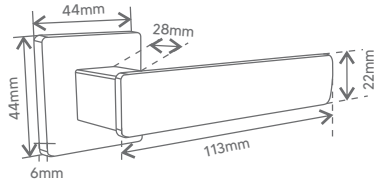

Olympia 07 - Quadrada Pequena

DESENHOS TÉCNICOS - LINHA POP

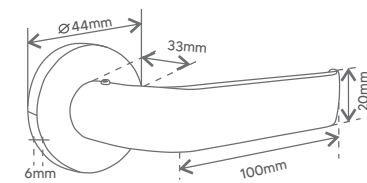

Stillus 04 - Redonda Pequena

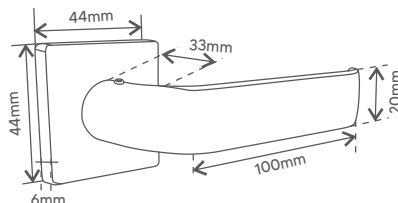

Stillus 07 - Quadrada Pequena

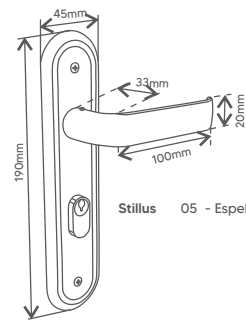

Stillus 05 - Espelho

DESENHOS TÉCNICOS - LINHA GOL

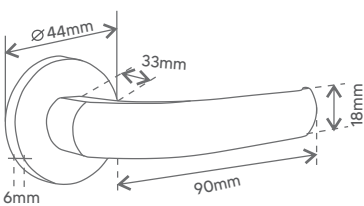

Gol 04 - Redonda Pequena

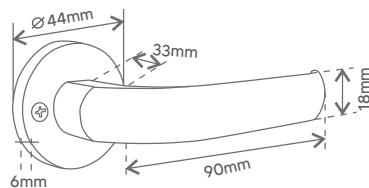

Gol 06 - Redonda Pequena
c/ parafuso aparente

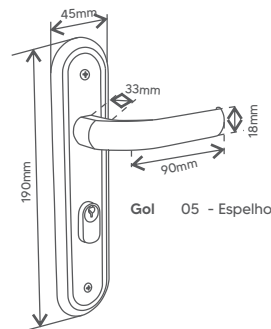

Gol 05 - Espelho

Entenda o código da Fechadura Mecânica

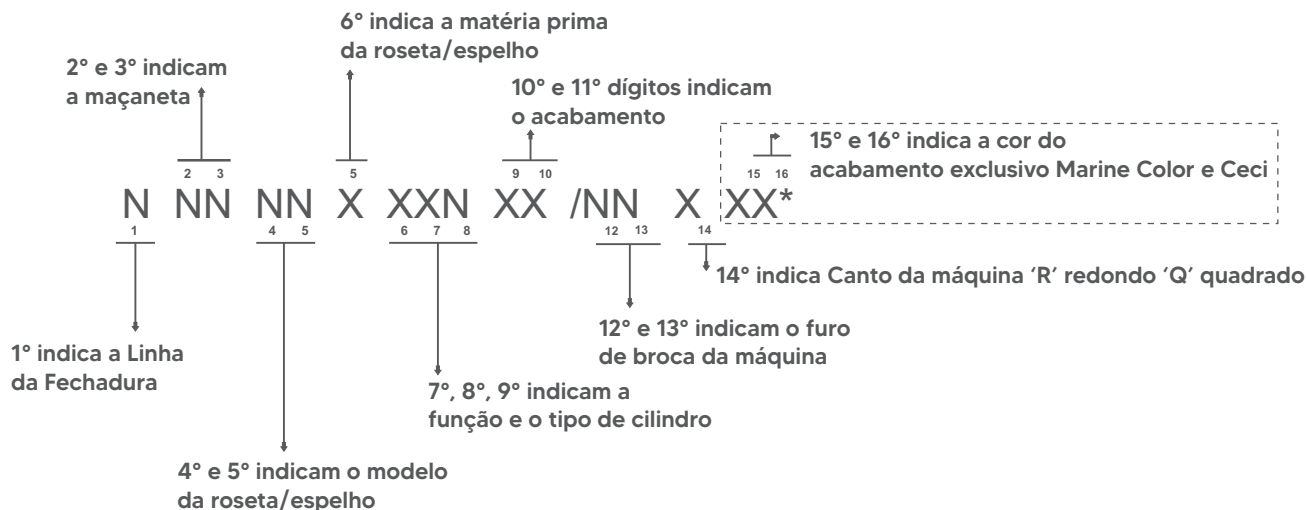

1° Cada linha de fechadura possui um número:

- 1 = Linha Synter GOL
- 2 = Linha Synter POP
- 5 = Linha Synter FLEX
- 7 = Linha Synter INOX - PRIME E UNIC

2° e 3° Cada modelo de maçaneta possui um número:

- | | | |
|---|--|--|
| Linha Synter GOL
(Maçaneta em Zamac) | Linha Synter POP
(Maçanetas em Zamac) | Linha Synter FLEX
(Maçanetas em Zamac) |
| 10 = Maçaneta Gol | 11 = Maçaneta Stillus | 15 = Maçaneta Olympia
16 = Maçaneta Gloriam |

Synter INOX - Linhas Prime e Unic
(Maçanetas em Aço Inox)

- 20 = Maçaneta Acqua Max
- 21 = Maçaneta Champion
- 22 = Maçaneta Marine
- 23 = Maçaneta Navis II
- 24 = Maçaneta Navis
- 28 = Maçaneta Star
- 29 = Maçaneta Marine Color
- 30 = Maçaneta Luck
- 31 = Maçaneta Crispus
- 32 = Maçaneta Star Max
- 33 = Maçaneta Polo
- 41 = Maçaneta Ceci

4° e 5° Cada roseta e espelho possui um número diferente:

- | | | |
|--|----------|---|
| 01 = Roseta Redonda Grande Inox | } -----> | Linhas Synter
PRIME, UNIC e FLEX
Somente : Ceci |
| 09 = Roseta Quadrada Grande Inox | | |
| 10 = Roseta Redonda Grande INOX (c/ parafusos aparente) | | |
| 04 = Roseta Redonda Pequena Inox | } -----> | Linhas Synter
FLEX, POP, GOL |
| 05 = Espelho Médio Inox | | |
| 06 = Roseta Redonda Pequena Inox (c/ parafusos aparente) | -----> | Linha Synter GOL |
| 04 = Roseta Redonda Pequena Inox | } -----> | Linhas Synter
PRIME, UNIC, FLEX e POP |
| 07 = Roseta Quadrada Pequena Inox | | |
| 08 = Roseta Redonda Fixa Inox | -----> | Somente na
maçaneta Acqua |
| 13 = Roseta Redonda Grande Inox | } -----> | Crispus Max
Star Max
Polo Max |
| 14 = Roseta Quadrada Grande Inox | | |
| 15 = Roseta Quadrada Grande Inox | | |

10° e 11° Os acabamentos são indicados por letras:

- | | |
|------------------|------------------------|
| CR = Cromado | IE = Inox Escovado |
| IP = Inox Polido | PT = All Black (preto) |

12° e 13° A máquina da fechadura é indicada por / seguida do tamanho:

- /40 = Máquina de 40mm
- /55 = Máquina de 55mm

14° O de usinagem da máquina é indicado por:

- R = Canto redondo
- Q = Canto quadrado

15° e 16° Indica o acabamento da ponta da maçaneta exclusivo para Maçaneta Ceci e Marine Color

- CZ = Cinza

6° A matéria-prima das rosetas e espelhos é indicada por letras:

- I = Inox

7°, 8° e 9° As funções da fechadura são indicadas por letras:

- B = Banheiro
- I = Interna
- Ez1 = Externa c/ Cilindro de Zamac 62mm

Obs.: As fechaduras auxiliares ou digitais possuem codificação diferente.

AUXILIARES

Nossas fechaduras auxiliares são desenvolvidas com o mesmo rigor de qualidade que define todas as nossas linhas.

Fechadura para Porta de Correr

Externa com Cilindro Europeu

Ref.: X209912IE4
Roseta: 12 - Máquina: 40mm
Função: Externa
Acabamento: Polido / Escovado / Preto

inox



Externa com Cilindro Europeu

Ref.: X209911IE4
Roseta: 11 - Máquina: 40mm
Função: Externa
Acabamento: Polido / Escovado / Preto

inox



Interna com Chave Dobrável e Concha Stand

Ref.: XFCCDS1IP/40RC
Acompanha 2 conchas (Ref.: 234I)
Concha com Chave dobrável - Máquina: 40mm
Função: Interna e Banheiro
Acabamento: Polido / Escovado / Preto

inox



Banheiro com Tranqueta Quadrada

Ref.: X209907IB
Roseta: 07 - Máquina: 40mm
Função: Banheiro
Acabamento: Polido / Escovado / Preto

inox



Banheiro com Tranqueta Quadrada

Ref.: X209909IB
Roseta: 09 - Máquina: 40mm
Função: Banheiro
Acabamento: Polido / Escovado / Preto

inox



Interna com Jaspe 220mm

Ref.: XFCCD.JASPEIP/40R
Acompanha 2 conchas (Ref.: XJASPE2201)
Jaspe 220mm com Chave dobrável
Máquina: 40mm
Função: Interna
Acabamento: Polido / Escovado
Preto - sob consulta

inox



Banheiro com Tranqueta Redonda

Ref.: X209904IB
Roseta: 04 - Máquina: 40mm
Função: Banheiro
Acabamento: Polido / Escovado / Preto

inox



Banheiro com Tranqueta Redonda

Ref.: X209901IB
Roseta: 01 - Máquina: 40mm
Função: Banheiro
Acabamento: Polido / Escovado / Preto

inox



Banheiro com tranqueta e Jaspe 220mm

Ref.: XFBC.JASPEIP/40R
Acompanha 2 conchas (Ref.: XJASPE2201)
Jaspe 220mm com tranqueta linha pop
Máquina: 40mm
Função: banheiro
Acabamento: Polido / Escovado
Preto - sob consulta

inox



Fechadura Rolete

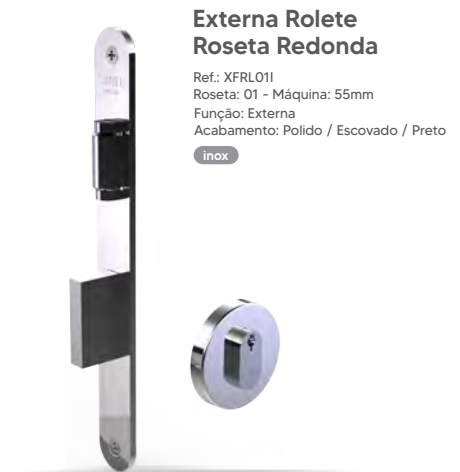

*Disponível também com testa quadrada

Acabamentos com excelência | Maçanetas, rosetas, falsa testa e contra testa em aço inoxidável; Disponível com Cilindro Europeu 60mm e Yale 62mm.

- Alta Durabilidade
- Produtos Premium
- Indicado para ambientes internos e externos
- Design Diferenciado
- Resistente à maresia
- Utilização em esquadrias de madeira em geral

DESENHOS TÉCNICOS - AUXILIARES

Fechadura para Porta de Correr

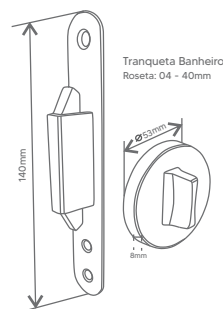
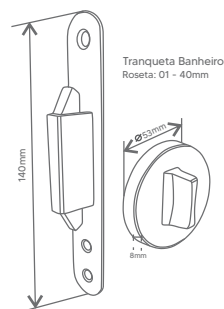
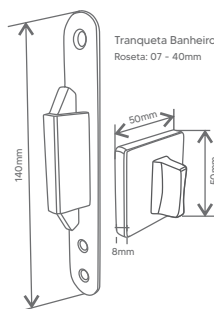
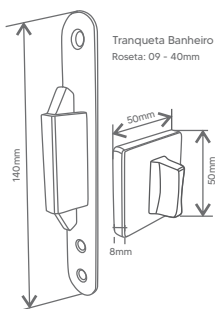
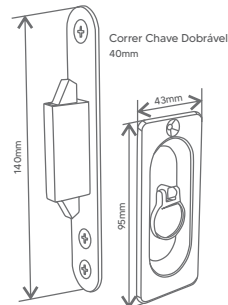
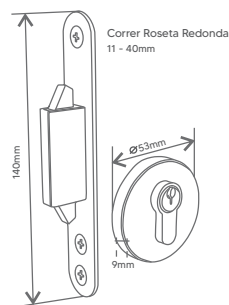
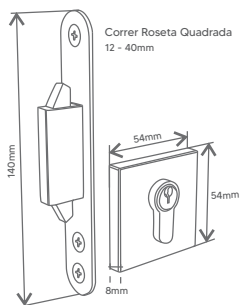

Fechadura Rolete

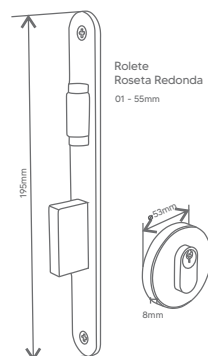
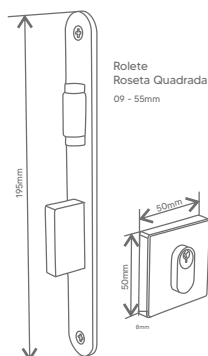

Rosetas

Roseta Grande Redonda - Inox
Ref.: 01, 10

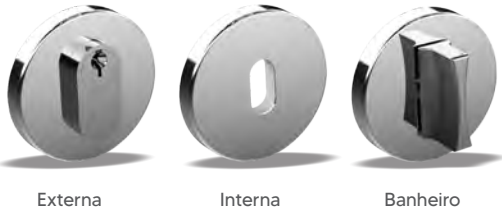

Externa

Interna

Banheiro

Roseta Pequena Redonda - Inox
Ref.: 04

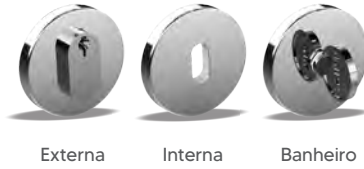

Externa

Interna

Banheiro

Roseta Grande Quadrada - Inox
Ref.: 09

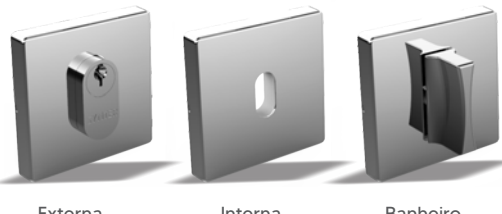

Externa

Interna

Banheiro

Roseta Pequena Quadrada - Inox
Ref.: 07



Externa

Interna

Banheiro

Roseta Grande Redonda Fixa - Inox
Ref.: 08, 13

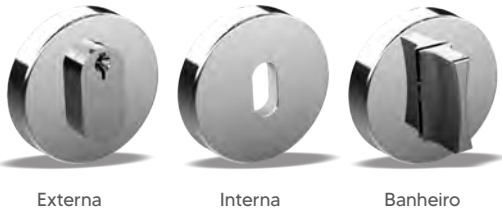

Externa

Interna

Banheiro

Roseta Pequena Redonda c/ parafuso aparente - Inox
Ref.: 06



Externa

Interna

Banheiro

Roseta Grande Quadrada Fixa - Inox
Ref.: 14, 15

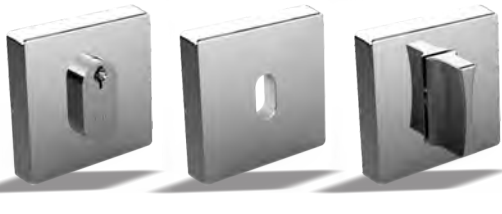

Externa

Interna

Banheiro

Espelho - Inox
Ref.: 05



Externa

Interna

Banheiro

Sistema de retorno de Mola (CRM)

Item aplicado em rosetas grandes



CRM é uma peça que aplicada entre a haste e a roseta reforça o retorno da maçaneta ao sua posição original. Em resumo, ele evita que a maçaneta fique com o aspecto de caída.

Máquinas

Tamanho de Broca 55mm
Canto Redondo e/ou Quadrado

Tamanho de Broca 40mm
Canto Redondo e/ou Quadrado

DESENHOS TÉCNICOS - MÁQUINAS EXTERNAS

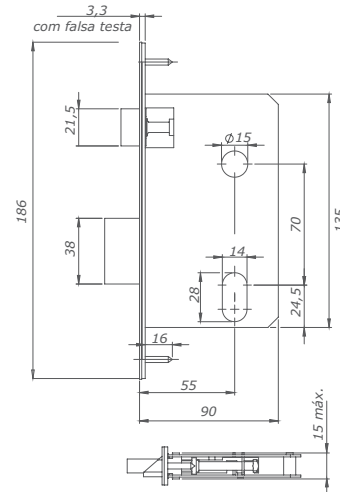
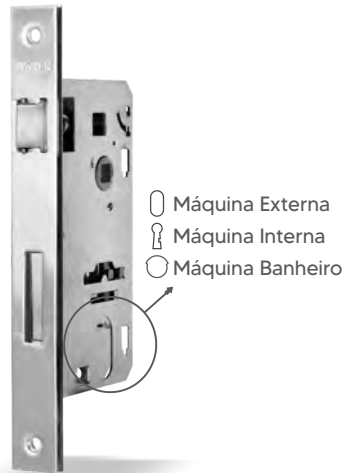

Máquina: 55mm

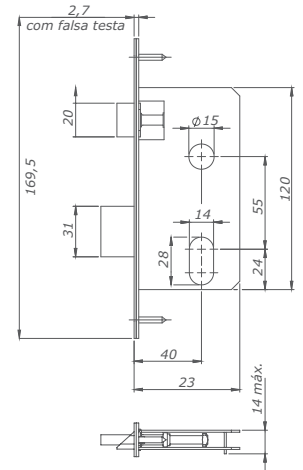

Máquina: 40mm

Frequência de Uso	Tamanho de Máq.	Utilização da Fechadura
Tráfego Intenso	Máquina 55mm	Residências, consultórios, escritórios, hospitais, shoppings centers, etc
Tráfego Médio	Máquina 55 e 40mm	Residências, consultórios, escritórios, etc.
Tráfego Leve	Máquina 40mm	Residências, comunicação entre cômodos, etc.
Grau de resistência à corrosão	Acabamentos	Utilização da Fechadura
4	Inox Polido e Escovado	Com condições severas quanto à umidade e intempéries (ex: região litorâneas e industriais)
3	Inox Polido e Escovado	Com umidade e intempéries (ex: áreas externas urbanas e rurais)
2	Cromado	Com umidade e sem intempéries (ex: cozinhas e banheiros)
1	Cromado	Sem umidade e sem intempéries (ex: salas e dormitórios)
Grau de segurança	Utilização da Fechadura	
Máxima	Porta externa, interna e banheiro	
Muito Alta	Porta externa, interna e banheiro	
Alta	Porta externa, interna e banheiro	
Média	Porta externa, interna e banheiro	
Média	Porta interna e banheiro	

Conforme ABNT/NBR 14913

Cilindro

Cilindro padrão Yale / 62mm
Ref.: CILEZ1CR

DESENHO TÉCNICO - CILINDRO 62MM

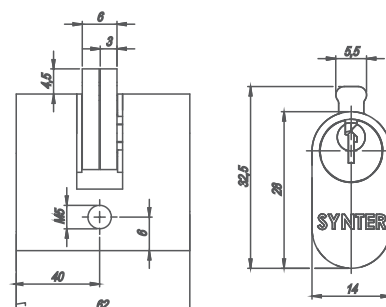

PUXADORES

Produzidos em aço inox 304, com acabamento em autobrilho e encaixe perfeito, garantem beleza e funcionalidade para portas de todos os estilos.

Jade Max

Ref.: XPUXJADEMAX
Tamanho: 1200mm / 800mm
Acabamento: Polido / Escovado / Preto

inox



Jade

Ref.: XPUXJADE
Tamanho: 1200mm / 800mm / 600mm
Acabamento: Polido / Escovado / Preto

inox



Opala

Ref.: XPUXOPALA
Tamanho: 1200mm / 800mm / 600mm
Acabamento: Polido / Escovado / Preto

inox



Quartzo

Ref.: XPUXQUARTZO
Tamanho: 800mm / 600mm / 300mm
Acabamento: Polido / Escovado / Preto

inox



Jaspe com Furo

Ref.: XPUXJASPECF
Tamanho: 520mm / 320mm / 220mm
Acabamento: Polido / Escovado / Preto

inox



Vendido em par

Jaspe

Ref.: XPUXJASPE
Tamanho: 520mm / 320mm / 220mm
Acabamento: Polido / Escovado / Preto

inox



Vendido em par



Alta Durabilidade



Ecologicamente Correto



Resistente à maresia



Utilização em esquadrias de madeira em geral



Indicado para ambientes internos e externos

DESENHOS TÉCNICOS - PUXADORES

Jade Max

1200mm / 800mm

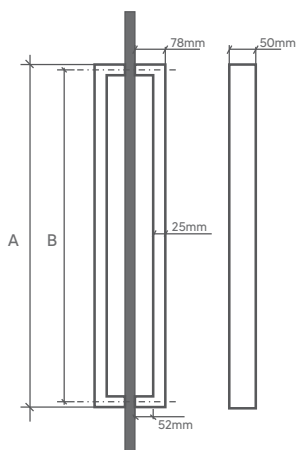

Referência	A	B
XPUXJADEMAX1200	1200mm	1175mm
XPUXJADEMAX800	800mm	775mm
XPUXJADEMAXPT1200	1200mm	1175mm

Jade

1200mm / 800mm / 600mm

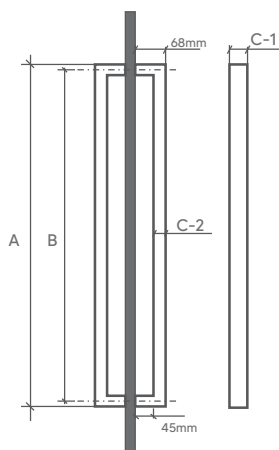

Referência	A	B	C-1 / C-2
XPUXJADEI1200	1200mm	1175mm	48X30mm
XPUXJADEI800	800mm	720mm	38x25mm
XPUXJADEI600	600mm	575mm	38X20mm
XPUXJADEIE1200	1200mm	1175mm	48X30mm
XPUXJADEIE800	800mm	720mm	38x25mm
XPUXJADEIE600	600mm	575mm	38X20mm
XPUXJADEPT1200	1200mm	1175mm	48X30mm
XPUXJADEPT800	800mm	720mm	38x25mm
XPUXJADEPT600	600mm	575mm	38X20mm

Opala

1200mm / 800mm / 600mm

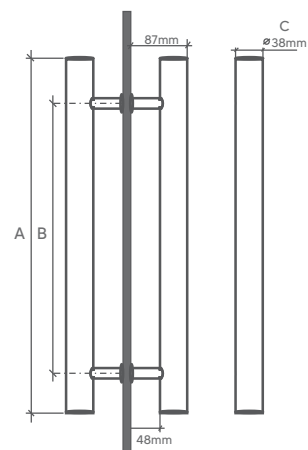

Referência	A	B	C
XPUXOPALA1200	1200mm	800mm	38mm
XPUXOPALA800	800mm	600mm	38mm
XPUXOPALA600	600mm	400mm	38mm
XPUXOPALAE800	1200mm	800mm	38mm
XPUXOPALAPT800	800mm	600mm	38mm

Quartzo

800mm / 600mm / 300mm

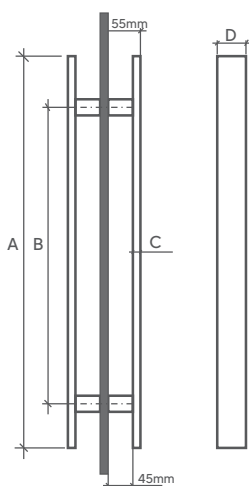

Referência	A	B	C	D
XPUXQUARTZO800	800mm	600mm	10mm	40mm
XPUXQUARTZO600	600mm	400mm	10mm	40mm
XPUXQUARTZO300	300mm	200mm	10mm	40mm
XPUXQUARTZOIE800	800mm	600mm	10mm	40mm
XPUXQUARTZOPT800	600mm	400mm	10mm	40mm
XPUXQUARTZOPT600	300mm	200mm	10mm	40mm
XPUXQUARTZOPT300	300mm	200mm	10mm	40mm

Jaspe com Furo

520mm / 320mm / 220mm

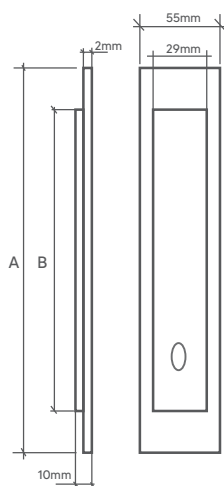

Referência	A	B
XPUXJASPECFIP520S	520mm	460mm
XPUXJASPECFIP320S	320mm	260mm
XPUXJASPECFIP220S	220mm	160mm
XPUXJASPECFIE220S	220mm	160mm
XPUXJASPECFPT320S	320mm	260mm
XPUXJASPECFPT220S	220mm	160mm

Jaspe

520mm / 320mm / 220mm

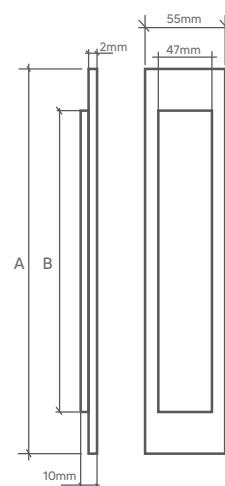

Referência	A	B
XPUXJASPEIP520S	520mm	460mm
XPUXJASPEIP320S	320mm	260mm
XPUXJASPEIP220S	220mm	160mm
XPUXJASPEIE520S	520mm	460mm
XPUXJASPEIE220S	220mm	160mm
XPUXJASPEPT320S	320mm	260mm
XPUXJASPEPT220S	220mm	160mm

DOBRADIÇAS INOX 304 PREMIUM

Uma linha de produtos variados para os mais diversos tipos de esquadrias.

Dobradiça

Com Rolamento Canto Reto

Tamanho: 4x3

Acabamento: Polido / Escovado

inox 304



Dobradiça

Com Rolamento Canto Reto

Tamanho: 3 1/2"x3" / 3x2 1/2"

Acabamento: Polido / Escovado

inox 304



Dobradiça

Com Rolamento Raio 16

Tamanho: 3 1/2"x3" / 3x2 1/2"

Acabamento: Polido / Escovado

inox 304



Dobradiça

Pino Simples Canto Reto

Tamanho: 2" 1/2 / 3" / 3 1/2" / 3x2 1/2" / 3x3

Acabamento: Polido / Escovado / Preto

inox 304



Dobradiça

Pino Simples Raio 16

Tamanho: 3x2 1/2"

Acabamento: Polido / Escovado / Preto

inox 304



Dobradiça

Pino Simples Canto Reto

Tamanho: 1/2" / 2"

Acabamento: Polido / Escovado / Preto

inox 304



Dobradiça

Pino Pivotante

Peso suportado: 150kg / 300kg

Acabamento: Escovado / Preto (sob consulta)

inox 304



 Resistente à maresia

 Alta Durabilidade

 Aço Inoxidável

 Qualidade garantida

DOBRADIÇAS MÁXIMA INOX

Dobradiça

Com Rolamento Canto Reto

Tamanho: 3x2 1/2" / 3 1/2"x3"

Acabamento: Polido / Escovado

inox 201



Dobradiça

Com Rolamento Raio 16

Tamanho: 3x2 1/2" / 3 1/2"x3"

Acabamento: Polido / Escovado

inox 201



Dobradiça

Sobrepôr Canto Reto

Tamanho: 4x3"

Acabamento: Polido / Escovado

inox 201



Aço Inoxidável



Durabilidade



Qualidade garantida

DOBRADIÇAS AÇO BASIC



Produto acessível



Qualidade garantida

Dobradiça

Com Anéis Canto Reto

Tamanho: 3x2 1/2"

Acabamento: Cromado

Aço Cromado



Dobradiça

Com Anéis Raio 16

Tamanho: 3x2 1/2"

Acabamento: Cromado

Aço Cromado



Dobradiça

Pino Luxo Canto Reto

Tamanho: 3x2 1/2"

Acabamento: Cromado

Aço Cromado



Dobradiça

Pino Luxo Raio 16

Tamanho: 3x2 1/2"

Acabamento: Cromado

Aço Cromado



Dobradiça
Sobrepor Canto Reto
 Tamanho: 4x3"
 Acabamento: Cromado
 Aço Cromado (sob consulta)



Dobradiça
Pino Simples Canto Reto
 Tamanho: 3" / 3x2 1/2"
 Acabamento: Zincado
 Aço Zincado



Dobradiça
Pino Simples Raio 16
 Tamanho: 3x2 1/2"
 Acabamento: Zincado
 Aço Zincado



Dobradiça
Linha Pesada - 2mm Raio 16
 Tamanho: 3x2 1/2"
 Acabamento: Zincado
 Aço Zincado



INFORMAÇÕES DOS PRODUTOS - DOBRADIÇAS INOX 304 PREMIUM

Dobradiça
Com Rolamento Canto Reto
 inox

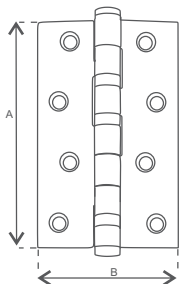

Dimensões	Medidas A	Medidas B	Espessura	Acabamento	Ref. peça (unid.)	Ref. cartela	Ref. caixa
4x3	101,45mm	76,55mm	2mm	Inox Polido	X707IXP	X707IXC-3 pçs.	X707IXPCX-12 pçs.

Dobradiça
Com Rolamento Canto Reto
 inox

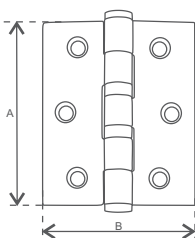

Dimensões	Medidas A	Medidas B	Espessura	Acabamento	Ref. peça (unid.)	Ref. cartela	Ref. caixa
3 1/2 x 3"	89mm	76mm	2mm	Inox Escovado	X700IXP	X700IXC-3 pçs.	X700IXPCX-24 pçs.
3 1/2 x 3"	89mm	76mm	2mm	Inox Polido	X701IXP	X701IXC-3 pçs.	X701IXPCX-24 pçs.
3x2 1/2 "	76mm	64mm	2mm	Inox Escovado	X705IXP	X705IXC-3 pçs.	X705IXPCX-24 pçs.
3x2 1/2 "	76mm	64mm	2mm	Inox Polido	X706IXP	X706IXC-3 pçs.	X706IXPCX-24 pçs.

Dobradiça
Com Rolamento Raio 16
 inox

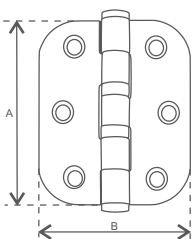

Dimensões	Medidas A	Medidas B	Espessura	Acabamento	Ref. peça (unid.)	Ref. cartela	Ref. caixa
3 1/2 x 3"	89mm	76mm	2mm	Inox Escovado	X700IER16P	X700IER16C-3 pçs.	X700IER16PCX-24 pçs.
3 1/2 x 3"	89mm	76mm	2mm	Inox Polido	X701IPR16P	X701IPR16C-3 pçs.	X701IPR16PCX-24 pçs.
3x2 1/2 "	76mm	64mm	2mm	Inox Escovado	X705IER16P		X705IER16PCX-24 pçs.
3x2 1/2 "	76mm	64mm	2mm	Inox Polido	X706IPR16P		X706IPR16PCX-24 pçs.

Dobradiça
Pino Pivotante Raio 16
 inox

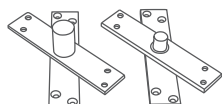

Peso suportado	Medidas A	Medidas B	Medidas C	Diâmetro	Acabamento	Ref. cartela
150kg	101mm	24,5mm	3,5mm	18	Inox Escovado	X800PIEC-conj. 4 pçs.
300kg	150mm	26mm	4,5mm	24,5	Inox Excovado	X810PIEC-conj. 4 pçs.

Dobradiça

Americana Pino Simples Canto Reto

inox

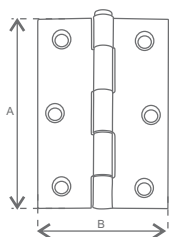

Dimensões	Medidas A	Medidas B	Espessura	Acabamento	Ref. peça (unid.)	Ref. cartela	Ref. caixa
2 1/2"	76mm	47mm	1,5mm	Inox Polido	X20I	X20IC-3 pçs.	X20ICX-24 pçs.
3"	85mm	56mm	1,5mm	Inox Polido	X30I	X30IC-3 pçs.	X30ICX-24 pçs.
3 1/2"	76mm	62mm	1,5mm	Inox Polido	X40I	X40IC-3 pçs.	X40ICX-12 pçs.
3x2 1/2 "	76mm	62mm	1,5mm	Inox Polido	X54I	X54IC-3 pçs.	X54ICX-24 pçs.
3x3	76mm	62mm	1,5mm	Inox Polido	X56I	X56IC-3 pçs.	X56ICX-24 pçs.

Dobradiça

Americana Pino Simples Raio 16

inox

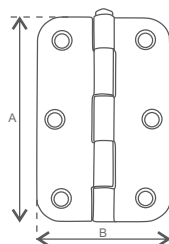

Dimensões	Medidas A	Medidas B	Espessura	Acabamento	Ref. peça (unid.)	Ref. caixa
3x2 1/2 "	76mm	62mm	1,5mm	Inox Polido	X54IPR16	X54IPR16CX-24 pçs.
3x2 1/2 "	76mm	62mm	1,5mm	Inox Escovado	X54IER16	X54IER16CX-24 pçs.

Dobradiça

Americana Pino Simples Canto Reto

inox

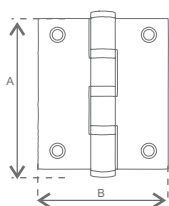

Dimensões	Medidas A	Medidas B	Espessura	Acabamento	Ref. peça (unid.)	Ref. cartela	Ref. caixa
1 1/2	38,2mm	32,4mm	1mm	Inox Polido	X15I	X15IC-3 pçs.	X15ICX-24 pçs.
2"	50,8mm	43,6mm	1mm	Inox Polido	X18I	X18IC-3 pçs.	X18ICX-24 pçs.

INFORMAÇÕES DOS PRODUTOS - DOBRADIÇAS MÁXIMA INOX

Dobradiça

Com Rolamento Canto Reto

inox

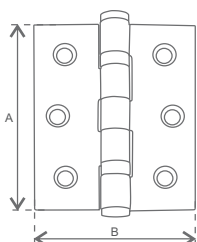

Dimensões	Medidas A	Medidas B	Espessura	Acabamento	Ref. peça (unid.)	Ref. cartela	Ref. caixa
3 1/2 x 3"	88,45mm	75,30mm	2mm	Inox Escovado	X100IXP	X100IXC-3 pçs.	X100IXPCX-24 pçs.
3 1/2 x 3"	88,45mm	75,30mm	2mm	Inox Polido	X101IXP	X101IXC-3 pçs.	X101IXPCX-24 pçs.
3x2 1/2 "	75,35mm	62,70mm	2mm	Inox Escovado	X105IXP	X105IXC-3 pçs.	X105IXPCX-24 pçs.
3x2 1/2 "	75,35mm	62,70mm	2mm	Inox Polido	X106IXP	X106IXC-3 pçs.	X106IXPCX-24 pçs.

Dobradiça

Com Rolamento Raio 16

inox

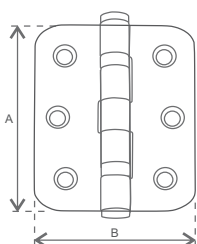

Dimensões	Medidas A	Medidas B	Espessura	Acabamento	Ref. peça (unid.)	Ref. cartela	Ref. caixa
3 1/2 x 3"	88,45mm	75,30mm	2mm	Inox Escovado	X100IER16P		X100IER16PCX-24 pçs.
3 1/2 x 3"	88,45mm	75,30mm	2mm	Inox Polido	X101IPR16P		X101IPR16PCX-24 pçs.
3x2 1/2 "	75,35mm	62,70mm	2mm	Inox Escovado	X105IER16P	X105IER16C-3 pçs.	X105IER16PCX-24 pçs.
3x2 1/2 "	75,35mm	62,70mm	2mm	Inox Polido	X106IPR16P	X106IPR16C-3 pçs.	X106IPR16PCX-24 pçs.

Dobradiça

Sobrepor Canto Reto

inox

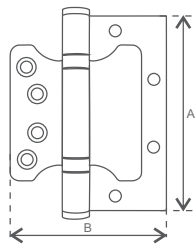

Dimensões	Medidas A	Medidas B	Espessura	Acabamento	Ref. caixa
4x3"	99mm	78mm	2mm	Inox Polido	X360SIPPCX2-2 pçs.
4x3"	99mm	78mm	2mm	Inox Escovado	X360SIEPCX2-2 pçs.

INFORMAÇÕES DOS PRODUTOS - DOBRADIÇAS AÇO BASIC

Dobradiça

Com Anéis Canto Reto

Aço Cromado

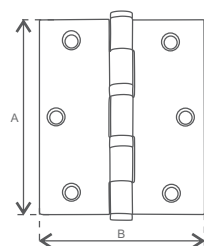

Dimensões	Medidas A	Medidas B	Espessura	Acabamento	Ref. peça (unid.)	Ref. cartela	Ref. caixa
3x2 1/2 "	75,35mm	62,70mm	2mm	Cromado	X105FCP	X105FCC-3 pçs.	X105FCPCX-24 pçs.

Dobradiça

Com Anéis Raio 16

Aço Cromado

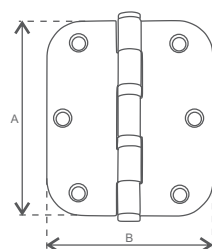

Dimensões	Medidas A	Medidas B	Espessura	Acabamento	Ref. peça (unid.)	Ref. caixa
3x2 1/2 "	75,35mm	62,70mm	2mm	Cromado	X105FCR16P	X105FCR16PCX-24 pçs.

Dobradiça

Pino Luxo Canto Reto

Aço Cromado

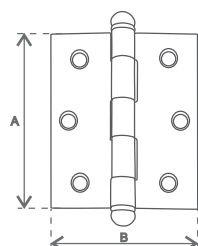

Dimensões	Medidas A	Medidas B	Espessura	Acabamento	Ref. peça (unid.)	Ref. cartela	Ref. caixa
3x2 1/2 "	76mm	64mm	2mm	Cromado	X601FCP	X601FCC-3 pçs.	X601FCPCX-24 pçs.

Dobradiça

Pino Luxo Raio 16

Aço Cromado

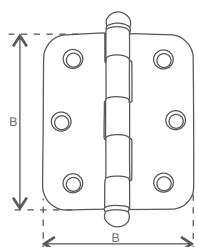

Dimensões	Medidas A	Medidas B	Espessura	Acabamento	Ref. peça (unid.)	Ref. cartela	Ref. caixa
3x2 1/2 "	76mm	64mm	2mm	Cromado	X601FCR16P	X601FCR16C-3 pçs.	X601FCR16PCX-24 pçs.

Dobradiça

Sobrepôr

Canto Reto

Aço Cromado

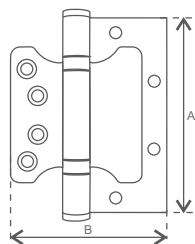

Dimensões	Medidas A	Medidas B	Espessura	Acabamento	Ref. caixa
4x3"	100mm	74mm	3mm	Cromado	X360SIPPCX2-2 pçs.

Dobradiça

Pino Simples

Canto Reto

Aço Zincado

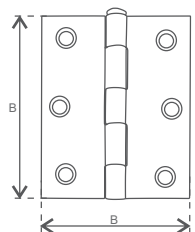

Dimensões	Medidas A	Medidas B	Espessura	Acabamento	Ref. peça (unid.)	Ref. cartela	Ref. caixa
2"	51mm	44mm	1mm	Zincado	X18FZ	X18FZC-3 pçs.	
2 1/2"	62mm	45mm	1mm	Zincado	X20FZ	X20FZC-3 pçs.	
3"	76mm	50mm	2mm	Zincado	X30FZ	X30FZC-3 pçs.	X30FZCX-24 pçs.
3 1/2"	85mm	76mm	2mm	Zincado	X40FZ	X40FZC-3 pçs.	X40FZCX-24 pçs.
3x2 1/2"	76mm	62mm	2mm	Zincado	X50FZ	X50FZC-3 pçs.	X50FZCX-24 pçs.

Dobradiça

Pino Simples Raio 16

Aço Zincado

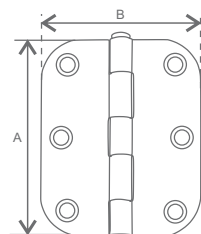

Dimensões	Medidas A	Medidas B	Espessura	Acabamento	Ref. peça (unid.)	Ref. cartela	Ref. caixa
3x2 1/2"	76mm	62mm	1,5mm	Zincado	X50FZR16P	X50FZR16C-3 pçs.	X50FZR16CX-24 pçs.

Dobradiça

Linha Pesada Raio 16

Aço Zincado

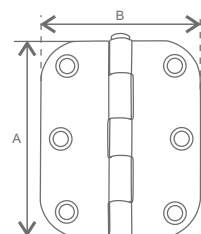

Dimensões	Medidas A	Medidas B	Espessura	Acabamento	Ref. peça (unid.)	Ref. caixa
3x2 1/2"	76mm	62mm	3mm	Zincado	X550FZR16P	X550FZR16CX-24 pçs.

FERRAGENS

Fecho Fio Redondo

Polido

inox



Fecho Pino Bola

Polido / Preto - sob consulta

inox



Fecho Fio Chato

Polido

inox



Fecho Porta Cadeado

Acabamento: Polido

inox

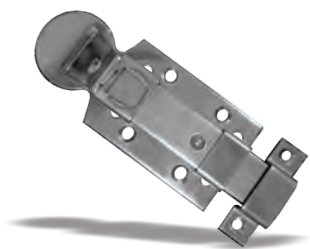

Fecho Concha Trava

Acabamento: Polido / Preto - sob consulta

inox



Fecho para janela de correr

Acabamento: Polido / Preto - sob consulta

inox



Concha Stand com furo

Acabamento: Polido / Preto - sob consulta

inox



Concha Stand

Acabamento: Polido / Preto - sob consulta

inox



Alça

Acabamento: Polido / Preto - sob consulta

inox



Borboleta para Guilhotina

Acabamento: Polido / Preto - sob consulta

inox



Levantador de Guilhotina

Acabamento: Polido / Preto - sob consulta

inox



Prendedor para Veneziana

Acabamento: Polido

inox



Cremona

Acabamento: Polido / Preto - sob consulta

inox



Vara para Cremona

Acabamento: Polido / Preto - sob consulta

inox



Gancho de Rede

Acabamento: Polido

inox



Prendedor de Porta Magnético

Acabamento: Escovado

inox



Prendedor de Porta Magnético

Acabamento: Escovado

inox



Amortecedor de Porta

Acabamento: Polido

zamac



Números

(1-9 fixação dupla face)

Acabamento: Polido

inox



Números (1-9)

Acabamento: Polido

inox



Porta Cadeado

Acabamento: Polido

inox



Dobradiça Basculante (gonzo)

Acabamento: Polido

inox

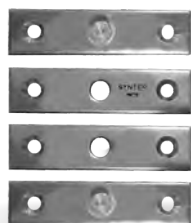

Dobradiça Basculante (gonzo)

Acabamento: Polido

inox



Dobradiça Leme

Acabamento: Polido

inox



Targeta

Acabamento: Polido

inox

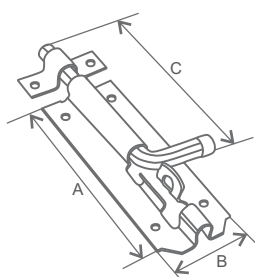

- Alta Durabilidade
- Ecologicamente Correto
- Indicado para ambientes internos e externos
- Resistente à maresia
- Utilização em esquadrias de madeira em geral

Fecho Fio Redondo

*sequência AxBxC

Dimensões	Acabamento	Ref. cartela	Ref. caixa
75x34x70mm	Polido	X282IC-1 pç.	X282ICX-10 pçs.
100x35x100mm	Polido	X283IC-1 pç.	X283ICX-10 pçs.
100x38x150,3mm	Polido	X285IC-1 pç.	
150x38x150,3mm	Polido	X286IC-1 pç.	
150x38x229mm	Polido	X288IC-1 pç.	

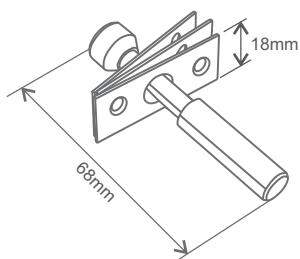
Fecho Pino Bola

Dimensões	Acabamento	Ref. cartela	Ref. caixa
70x18mm	Polido	X10IC-1 pç.	X10ICX-10 pçs.

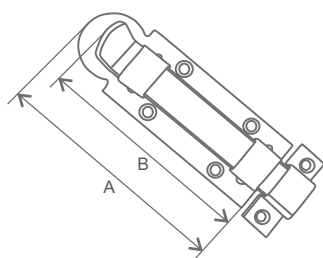
Fecho Fio Chato

*sequência AxB

Dimensões	Acabamento	Ref. cartela	Ref. caixa
62,2x20mm	Polido	X251IC-1 pç.	X251ICX-10 pçs.
88x30mm	Polido	X250IC-1 pç.	X250ICX-10 pçs.

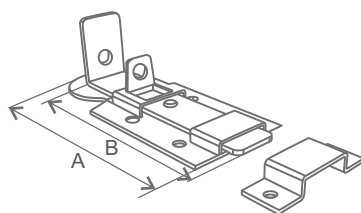
Fecho Porta Cadeado

*sequência AxB

Dimensões	Acabamento	Ref. cartela
108x47mm	Polido	X310IC-1 pç.
129,3x47mm	Polido	X311IC-1 pç.
154x47mm	Polido	X312IC-1 pç.

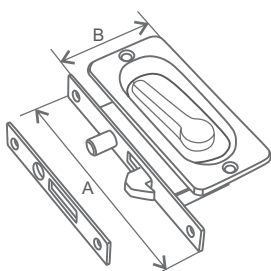
Fecho Concha Trava

*sequência AxB

Dimensões	Acabamento	Ref. cartela
110x61mm	Polido	X235IC-1 pç.

Fecho para Janela de Correr

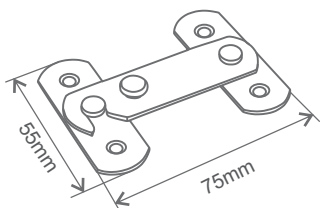

Dimensões	Acabamento	Ref. cartela	Ref. caixa
75X55mm	Polido	X51C-1 pç.	X51CX-10 pçs.

Concha Stand com Furo

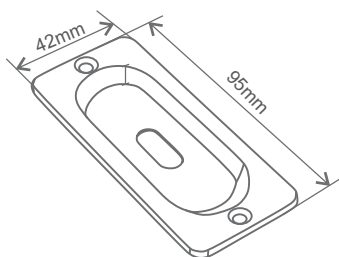

Dimensões	Acabamento	Ref. cartela	Ref. caixa
95X42mm	Polido	X2341C-1 pç.	X2341CX-10 pçs.

Concha Stand

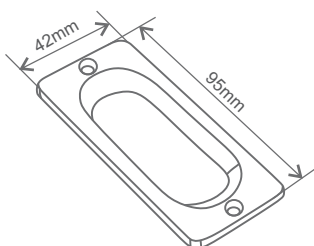

Dimensões	Acabamento	Ref. cartela	Ref. caixa
95X42mm	Polido	X2331C-1 pç.	X2331CX-10 pçs.

Alça

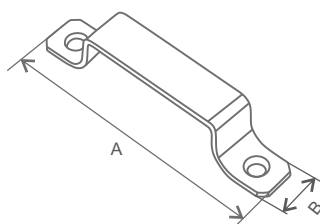

*sequência Ax B

Dimensões	Acabamento	Ref. cartela	Ref. caixa
88X15mm	Polido	X3001C-1 pç.	X3001CX-10 pçs.
111,8X15mm	Polido	X3011C-1 pç.	X3011CX-10 pçs.
137X15mm	Polido	X3021C-1 pç.	X3021CX-10 pçs.

Borboleta para Guilhotina

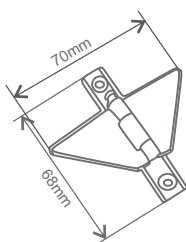

*sequência Ax B

Dimensões	Acabamento	Ref. cartela	Ref. caixa
68X70mm	Polido	X2001C-2 pçs.	X2001CX-10 pçs.

Levantador de Guilhotina

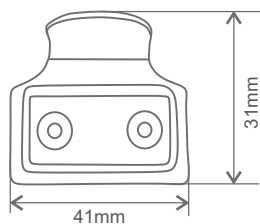

Dimensões	Acabamento	Ref. cartela	Ref. caixa
41x31mm	Polido	X210IC-2 pçs.	X210ICX-10 pçs.

Prendedor para Veneziana

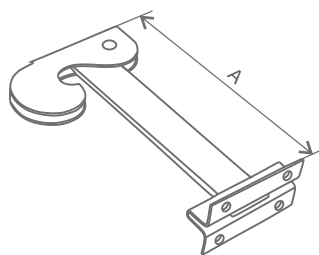

Dimensões	Acabamento	Ref. cartela	Ref. caixa
36mm	Polido	X220MIC-2 pçs.	X220MICX-10 pçs.
80mm	Polido	X222MIC-2 pçs.	

Cremona

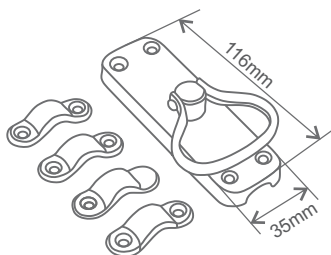

Dimensões	Acabamento	Ref. cartela	Ref. caixa
116x35mm	Polido	X116IC-1 pç.	X116IP-1 pç.

Vara de Cremona

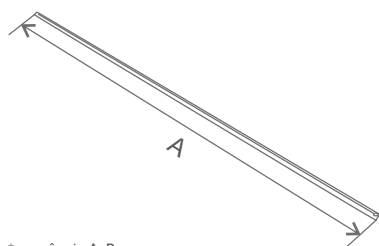

Dimensões	Acabamento	Ref. peça
1200mm	Polido	X1200I-1 pç.
1500mm	Polido	X1500I-1 pç.

*sequência Ax B

Gancho de Rede

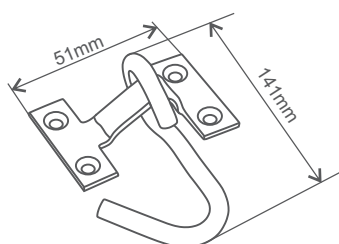

Dimensões	Acabamento	Ref. cartela	Ref. caixa
51x141mm	Polido	X260IMC-2 pçs.	X260IMCX-10 pçs.

Prendedor para Porta Magnético (fixação no piso ou parede)

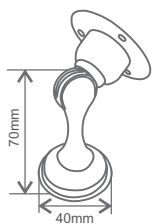

Dimensões	Acabamento	Ref. cartela
70x40mm	Escovado	XPRENDMAGC-1 pç.

Prendedor para Porta Magnético (fixação no piso)

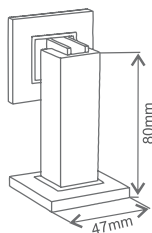

Dimensões	Acabamento	Ref. cartela
47x80mm	Escovado	XPRMAGQ3C-1 pç.

Amortecedor de Porta (fixação no piso)

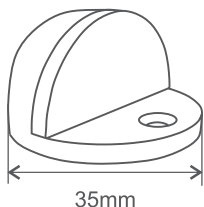

Dimensões	Acabamento	Ref. cartela
35mm	Cromado	XAMORTEC1C-1 pç.

Números (1-9 fixação com dupla face)



Dimensões	Acabamento	Ref. cartela
125x85mm	Polido	XN0DFIPC-1 pç.
125x85mm	Polido	XN1DFIPC-1 pç.
125x85mm	Polido	XN2DFIPC-1 pç.
125x85mm	Polido	XN3DFIPC-1 pç.
125x85mm	Polido	XN4DFIPC-1 pç.
125x85mm	Polido	XN5DFIPC-1 pç.
125x85mm	Polido	XN6DFIPC-1 pç. Código válido para o número 6 e 9
125x85mm	Polido	XN7DFIPC-1 pç.
125x85mm	Polido	XN8DFIPC-1 pç.

Números (1-9 fixação com parafuso)

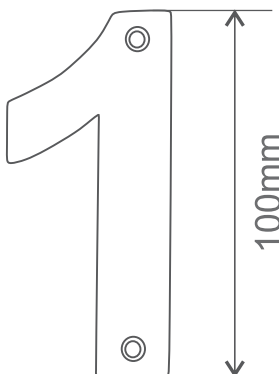

Dimensões	Acabamento	Ref. cartela
100mm	Polido	XN0IXC-1 pç.
100mm	Polido	XN1IXC-1 pç.
100mm	Polido	XN2IXC-1 pç.
100mm	Polido	XN3IXC-1 pç.
100mm	Polido	XN4IXC-1 pç.
100mm	Polido	XN5IXC-1 pç.
100mm	Polido	XN6IXC-1 pç. Código válido para o número 6 e 9
100mm	Polido	XN7IXC-1 pç.
100mm	Polido	XN8IXC-1 pç.

Porta Cadeado

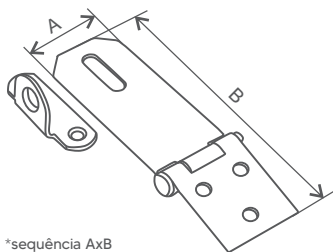

*sequência Ax B

Dimensões	Acabamento	Ref. cartela	Ref. caixa
25,2x60mm	Polido	X271IC-1 pç.	X271ICX-10 pçs.
47x140,7mm	Polido	X272IC-1 pç.	

Dobradiça Basculante (gonzo)

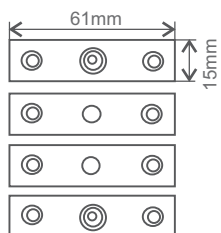

Dimensões	Acabamento	Ref. cartela
61X15mm	Polido	X240IC-1 pç.

Dobradiça Basculante (gonzo)

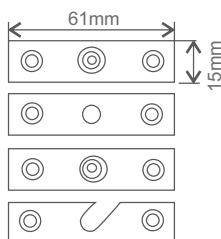

Dimensões	Acabamento	Ref. peça
61X15mm	Polido	X241IC-1 pç.

Dobradiça Leme

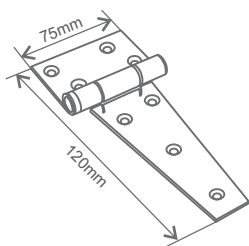

Dimensões	Acabamento	Ref. cartela	Ref. caixa
75X120mm	Polido	X331IC-1 pç.	X331ICX-10 pçs.

Targeta

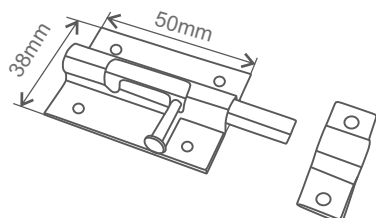

Dimensões	Acabamento	Ref. cartela	Ref. caixa
50x38mm	Polido	X280IC-1 pç.	X280ICX-10 pçs.



 **synter**

✉ contato@synter.com.br | ☎ +55 48 39411192
Rodovia Gabriel Arns, 5572, Cep: 88850-000
Forquilha - Santa Catarina